

Panasonic®

LCD Projector Commercial Use

Operating Instructions

ENGLISH

Model No. **PT-L735NTU**
PT-L735U

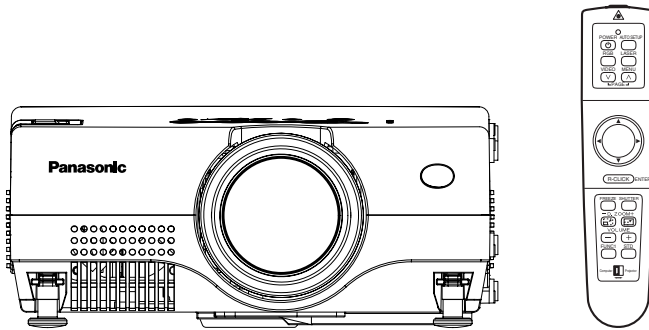

Before operating this product, please read the instructions carefully and save this manual for future use.

Dear Panasonic Customer:

This instruction booklet provides all the necessary operating information that you might require. We hope it will help you to get the most performance out of your new product, and that you will be pleased with your Panasonic LCD projector.

The serial number of your product may be found on its bottom. You should note it in the space provided below and retain this booklet in case service is required.

Model number: **PT-L735NTU / PT-L735U**

Serial number: _____

IMPORTANT SAFETY NOTICE

WARNING: TO REDUCE THE RISK OF FIRE OR ELECTRIC SHOCK, DO NOT EXPOSE THIS PRODUCT TO RAIN OR MOISTURE.

Power Supply: This LCD Projector is designed to operate on 100 V – 240 V, 50 Hz/60 Hz AC, house current only.

CAUTION: The AC power cord which is supplied with the projector as an accessory can only be used for power supplies up to 125 V, 7 A. If you need to use higher voltages or currents than this, you will need to obtain a separate 250 V power cord. If you use the accessory cord in such situations, fire may result.



The lightning flash with arrowhead symbol, within an equilateral triangle, is intended to alert the user to the presence of uninsulated “dangerous voltage” within the product’s enclosure that may be of sufficient magnitude to constitute a risk of electric shock to persons.



The exclamation point within an equilateral triangle is intended to alert the user to the presence of important operating and maintenance (servicing) instructions in the literature accompanying the product.

CAUTION: This equipment is equipped with a three-pin grounding-type power plug. Do not remove the grounding pin on the power plug. This plug will only fit a grounding-type power outlet. This is a safety feature. If you are unable to insert the plug into the outlet, contact an electrician. Do not defeat the purpose of the grounding plug.

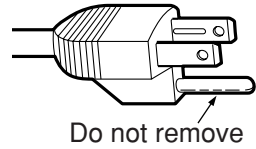

WARNING:

This equipment has been tested and found to comply with the limits for a Class B digital device, pursuant to Part 15 of the FCC Rules. These limits are designed to provide reasonable protection against harmful interference in a residential installation. This equipment generates, uses, and can radiate radio frequency energy and, if not installed and used in accordance with the instructions, may cause harmful interference to radio communications. However, there is no guarantee that interference will not occur in a particular installation. If this equipment does cause harmful interference to radio or television reception, which can be determined by turning the equipment off and on, the user is encouraged to try to correct the interference by one or more of the following measures:

- Reorient or relocate the receiving antenna.
- Increase the separation between the equipment and receiver.
- Connect the equipment into an outlet on a circuit different from that to which the receiver is connected.
- Consult the dealer or an experienced radio/TV technician for help.

FCC CAUTION: To assure continued compliance, use only shielded interface cables when connecting to computers or peripheral devices.

Any unauthorized changes or modifications to this equipment will void the users authority to operate.

WARNING:

Not for use in a computer room as defined in the Standard for the Protection of Electronic Computer/Data Processing Equipment, ANSI/NFPA 75.

Declaration of Conformity

Model Number: PT-L735NTU / PT-L735U

Trade Name: **Panasonic**

Responsible party: Matsushita Electric Corporation of America.

Address: One Panasonic Way Secaucus New Jersey 07094

Telephone number: 1-800-528-8601 or 1-800-222-0741

Email: pbtsservice@panasonic.com

This device complies with Part 15 of the FCC Rules, Operation is subject to the following two conditions: (1) This device may not cause harmful interference, and (2) this device must accept any interference received, including interference that may cause undesired operation.

Contents

Preparation

IMPORTANT SAFETY NOTICE ...2
Precautions with regard to safety5
Accessories9
Before use10
Location and function of each part.....12
Inserting the wireless card17

Getting started

Setting-up18
Projection methods, Projector position, Projection distances
Connections20
Example of connecting to video equipments, Example of connecting to computer
Preparation for the remote control unit.....22

Basic Operation

Turning on the power23
Turning off the power.....25

Useful functions

Correcting keystone distortion and automatic positioning.....27
Turning off the picture and sound momentarily28
Pausing a picture.....28
Enlarging the picture.....29
Adjusting the volume29
Useful functions of the remote control unit.....30
Laser beam pointer, Wireless mouse

Adjustments and settings

On-screen menus32
Menu screens, Menu operation guide, Returning a setting to the factory default
Adjusting the picture.....37
PICTURE MODE, CONTRAST, BRIGHT, COLOR, TINT, SHARPNESS, Color Hue Setting, Noise Reduction (NR), WHITE BALANCE R/G/B, TV-SYSTEM, Projecting sRGB-compatible pictures

Adjusting the position.....40
POSITION, DOT CLOCK, CLOCK PHASE, KEYSTONE, OSD POSION, ASPECT, RESIZING, AUTO SETUP, FRAME LOCK

Audio adjustment44
VOLUME, MUTE, AUDIO MODE

Changing the display language...44

Option settings45
OSD, AUTO SEARCH, AUTO SIGNAL, AUTO KEYSTN, RGB2 SELECT, RGB/YPbPr, VGA60/525P, BLACKBOARD, BACK COLOR, FRONT/REAR, DESK/CEILING, FAN CONTROL, LAMP POWER, LAMP RUN TIME, FUNC 1, CONTROL KEY, AUTO POWER OFF

Network setup48

SD card setup48

Setting up the SECURITY function49
PASSWORD SETTING, CHANGE PASSWORD, TEXT DISPLAY, CHANGE TEXT, LOGO DISPLAY, CLEAR, CAPTURE

Care and maintenance

When the TEMP indicator and the LAMP indicator are illuminated...52
Cleaning and replacing the air filter54
Replacing the lamp unit55
Before calling for service.....58
Cleaning and maintenance59

Others

Specifications60

Appendix62
List of compatible signals, Connector pin wiring, Projection dimensions calculation methods, Using the SERIAL connector

Dimensions66

Trademark acknowledgements...66
--

NOTES IMPORTANTES

CONCERNANT LA SÉCURITÉ...67
Précautions de sécurité68
Avant l'utilisation.....72
Remplacement du bloc de lampe...74

Precautions with regard to safety

WARNING

If a problem occurs (such as no image or no sound) or if you notice smoke or a strange smell coming from the projector, turn off the power and disconnect the power cord from the wall outlet.

- Do not continue to use the projector in such cases, otherwise fire or electric shocks could result.
- Check that no more smoke is coming out, and then contact an Authorized Service Center for repairs.
- Do not attempt to repair the projector yourself, as this can be dangerous.

Do not install this projector in a place which is not strong enough to take the full weight of the projector.

- If the installation location is not strong enough, it may fall down or tip over, and severe injury or damage could result.

Installation work (such as ceiling suspension) should only be carried out by a qualified technician.

- If installation is not carried out correctly, there is the danger that injury or electric shocks may occur.

If foreign objects or water get inside the projector, or if the projector is dropped or the cabinet is broken, turn off the power and disconnect the power cord from the wall outlet.

- Continued use of the projector in this condition may result in fire or electric shocks.
- Contact an Authorized Service Center for repairs.

Do not overload the wall outlet.

- If the power supply is overloaded (for example, by using too many adapters), overheating may occur and fire may result.

Do not remove the cover or modify it in any way.

- High voltages which can cause fire or electric shocks are present inside the projector.
- For any inspection, adjustment and repair work, please contact an Authorized Service Center.

Clean the power cord plug regularly to prevent it from becoming covered in dust.

- If dust builds up on the power cord plug, the resulting humidity can damage the insulation, which could result in fire. Pull the power cord out from the wall outlet and wipe it with a dry cloth.
- If not using the projector for an extended period of time, pull the power cord plug out from the wall outlet.

Do not do anything that might damage the power cord or the power cord plug.

- Do not damage the power cord, make any modifications to it, place it near any hot objects, bend it excessively, twist it, pull it, place heavy objects on top of it or wrap it into a bundle.
- If the power cord is used while damaged, electric shocks, short-circuits or fire may result.
- Ask an Authorized Service Center to carry out any repairs to the power cord that might be necessary.

Do not handle the power cord plug with wet hands.

- Failure to observe this may result in electric shocks.

Insert the power cord plug securely into the wall outlet.

- If the plug is not inserted correctly, electric shocks or overheating could result.
- Do not use plugs which are damaged or wall outlets which are coming loose from the wall.

Do not place the projector on top of surfaces which are unstable.

- If the projector is placed on top of a surface which is sloped or unstable, it may fall down or tip over, and injury or damage could result.

Do not place the projector into water or let it become wet.

- Failure to observe this may result in fire or electric shocks.

Do not place liquid containers on top of the projector.

- If water spills onto the projector or gets inside it, fire or electric shocks could result.
- If any water gets inside the projector, contact an Authorized Service Center.

Do not insert any foreign objects into the projector.

- Do not insert any metal objects or flammable objects into the projector or drop them onto the projector, as doing so can result in fire or electric shocks.

Keep the SD memory card (PT-L735NTU only) and batteries out of the reach of infants.

- If the memory card or batteries are swallowed, death by suffocation may result. If you believe that the memory card or batteries may have been swallowed, seek medical advice immediately.

Do not allow the + and - terminals of the batteries to come into contact with metallic objects such as necklaces or hairpins.

- Failure to observe this may cause the batteries to leak, overheat, explode or catch fire.
- Store the batteries in a plastic bag and keep them away from metallic objects.

During a thunderstorm, do not touch the projector or the cable.

- Electric shocks can result.

Do not use the projector in a bath or shower.

- Fire or electric shocks can result.

Do not look into the lens while the projector is being used.

- Strong light is emitted from the projector's lens. If you look directly into this light, it can hurt and damage your eyes.
- Be especially careful not to let young children look into the lens. In addition, turn off the power when you are away from the projector.

Keep the remote control unit out of the reach of children, and do not look into the laser beam or point it towards other people.

- If the laser beam which is emitted by the remote control unit transmitter is pointed directly into the eyes, it may cause visual ability to be impaired.

Do not bring your hands or other objects close to the air outlet port.

- Heated air comes out of the air outlet port. Do not bring your hands or face, or objects which cannot withstand heat close to this port, otherwise burns or damage could result.

When replacing the lamp, allow it to cool for at least one hour before handling it.

- The lamp cover gets very hot, and contact with it can cause burns.

Before replacing the lamp, be sure to unplug the power cord from the power outlet.

- Electric shocks or explosions can result if this is not done.

Caution

Do not cover the air inlet or the air outlet.

- Doing so may cause the projector to overheat, which can cause fire or damage to the projector.
- Do not place the projector in narrow, badly ventilated places such as closets or bookshelves.

Do not set up the projector in humid or dusty places or in places where the projector may come into contact with smoke or steam.

- Using the projector under such conditions may result in fire or electric shocks.

When disconnecting the power cord, hold the plug, not the cord.

- If the power cord itself is pulled, the cord will become damaged, and fire, short-circuits or serious electric shocks may result.

Always disconnect all cables before moving the projector.

- Moving the projector with cables still attached can damage the cables, which could cause fire or electric shocks to occur.

Do not place any heavy objects on top of the projector.

- Failure to observe this may cause the projector to become unbalanced and fall, which could result in damage or injury.

Do not short-circuit, heat or disassemble the batteries or place them into water or fire.

- Failure to observe this may cause the batteries to overheat, leak, explode or catch fire, and burns or other injury may result.

When inserting the batteries, make sure the polarities (+ and -) are correct.

- If the batteries are inserted incorrectly, they may explode or leak, and fire, injury or contamination of the battery compartment and surrounding area may result.

Use only the specified batteries.

- If incorrect batteries are used, they may explode or leak, and fire, injury or contamination of the battery compartment and surrounding area may result.

Do not mix old and new batteries.

- If the batteries are inserted incorrectly, they may explode or leak, and fire, injury or contamination of the battery compartment and surrounding area may result.

Do not put your weight on this projector.

- You could fall or the projector could break, and injury may result.
- Be especially careful not to let young children climb onto the projector.

Disconnect the power cord plug from the wall outlet as a safety precaution before carrying out any cleaning.

- Electric shocks can result if this is not done.

Do not install the accessory wireless card to any device other than the card slot of the projector. (PT-L735NTU only)

- If this is not observed, damage to the device may result.

Ask an Authorized Service Center to clean inside the projector at least once a year.

- If dust is left to build up inside the projector without being cleaned out, it can result in fire or problems with operation.
- It is a good idea to clean the inside of the projector before the season for humid weather arrives. Ask your nearest Authorized Service Center to clean the projector when required. Please discuss with the Authorized Service Center regarding cleaning costs.



We are constantly making efforts to preserve and maintain a clean environment. Please take non repairable units back to your dealer or a recycling company.

NOTICE:



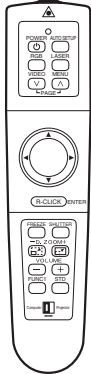
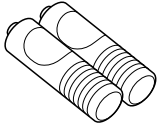
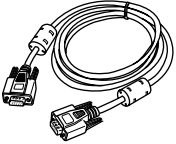
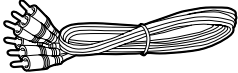
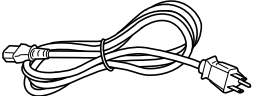
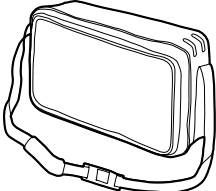

- This product has a High Intensity Discharge (HID) lamp that contains a small amount of mercury. It also contains lead in some components. Disposal of these materials may be regulated in your community due to environmental considerations. For disposal or recycling information please contact your local authorities, or the Electronics Industries Alliance: <<http://www.eiae.org.>>

Accessories

Check that all of the accessories shown below have been included with your projector.

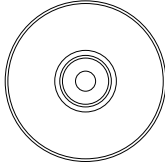
<p>Remote control unit (N2QAEA000015 x1)</p> 	<p>AAA batteries for remote control unit (x2)</p> 	<p>RGB signal cable [3.0 m (9'10"), K1HB15FA0001 x1]</p> 
	<p>Video/Audio cable [3.0 m (9'10"), K2KA2FA00002 x 1]</p> 	<p>Power cord (K2CG3FZ00008 x 1)</p> 
<p>Carrying bag (TPEP010 x1)</p> 	<p>USB cable (K1HB04FD0002 x 1)</p> 	

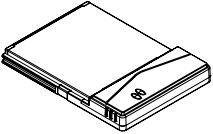
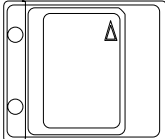
PT-L735NTU only

<p>CD-ROM (TQBH9004 x1)</p> 	<p>SD memory card (8 MB, RP-SD008BEZ0 x1)</p> 	<p>Wireless Card (N5HBD0000023 x1)</p> 
<p>Protective case for SD memory card (RP-SDCC0 x1)</p> 	<p>Hexagon wrench (TKLA0701 x1)</p> 	

Before use

Cautions when moving the projector

Be sure to attach the lens cover before moving the projector.

The projection lens is extremely susceptible to vibration and shocks. When moving the projector, use the accessory carrying bag. When placing the projector inside the carrying bag, position it so that the lens is facing upward.

Cautions regarding setting-up

Avoid setting up in places which are subject to vibration or shocks.

The internal parts can be damaged, which may cause malfunctions or accidents.

Do not set up the projector near high-voltage power lines or near motors.

The projector may be subject to electromagnetic interference.

If installing the projector to the ceiling, ask a qualified technician to carry out all installation work.

You will need to purchase the separate installation kit (Model No.ET-PK735). Furthermore, all installation work should only be carried out by a qualified technician.

If using this projector at high elevations (above 1400 m), set the FAN CONTROL to “HIGH”. (Refer to page 46.)

Failure to observe this may result in malfunctions.

Notes on use

In order to get the best picture quality

Draw curtains or blinds over any windows and turn off any fluorescent lights near the screen to prevent outside light or light from indoor lamps from shining onto the screen.

Do not touch the surfaces of the lens with your bare hands.

If the surface of the lens becomes dirty from fingerprints or anything else, this will be magnified and projected onto the screen. Moreover, when not using the projector, retract the lens and then cover it with the accessory lens cover.

About the screen

Do not apply any volatile substances which may cause discoloration to the screen, and do not let it become dirty or damaged.

About the wireless card and SD memory card

(PT-L735NTU only)

Static electricity from the human body can damage the wireless card or SD memory card. To prevent this, you should touch a nearby metallic object such as an aluminium sash or a door knob to dissipate the static charge from your body.

About the wireless card slot and SD memory card slot

(PT-L735NTU only)

Make sure that there are no foreign objects inside the slot when inserting the wireless card or SD memory card. Failure to observe it may damage the card and the slot.

About the lamp

The lamp may need to be replaced earlier due to variables such as individual lamp characteristics, usage conditions and the installation environment, especially when the projector is subjected to continuous use for more than 10 hours or the power is frequently turned on and off.

Location and function of each part

Projector <Top, right and front>

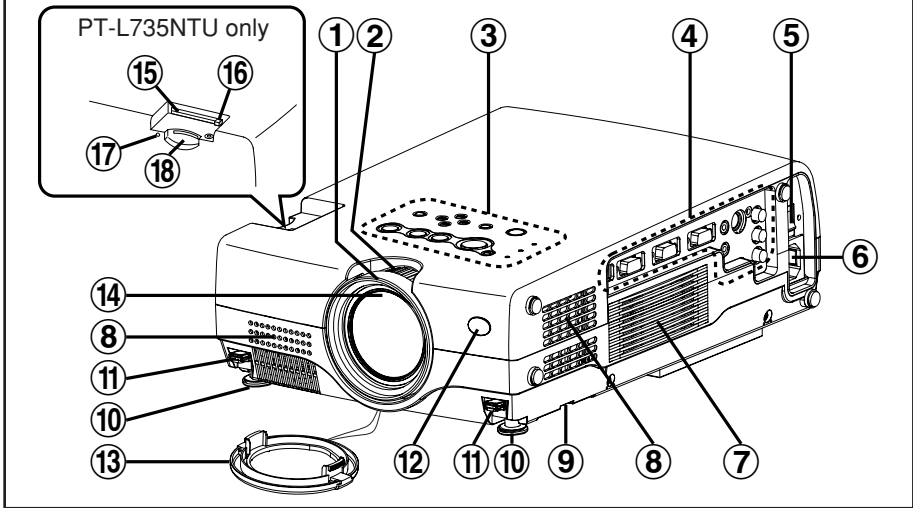

① **Focus ring**
(page 24)

② **Zoom ring**
(page 24)

③ **Projector control panel**
(page 14)

④ **Connector panel**
(page 16)

⑤ **MAIN POWER switch**
(pages 23 and 25)

⑥ **Power input socket (AC IN)**
(page 23)

The accessory power cord is connected here.
Do not use any power cord other than the accessory power cord.

⑦ **Speaker (L)**

⑧ **Air inlet ports**
Do not cover these ports.

⑨ **Air filter**
(page 54)

⑩ **Front adjustable legs(L/R)**
(page 24)

⑪ **Leg adjuster buttons(L/R)**
(page 24)

These buttons are used to unlock the front adjustable legs. Press to adjust the angle of tilt of the projector.

⑫ **Remote control signal receptor**
(page 22)

⑬ **Lens cover**

⑭ **Projection lens**

⑮ **Wireless card slot**
(PT-L735NTU only)
Insert the wireless card into here.
(Refer to page 17.)

⑯ **Eject switch**
(PT-L735NTU only)
Use to remove the wireless card from the card slot.

⑰ **Access lamp**
(PT-L735NTU only)
Flashes while the projector is being accessed for reading or writing the data in the SD memory card.

⑱ **SD memory card slot**
(PT-L735NTU only)
Insert the SD memory card into here.

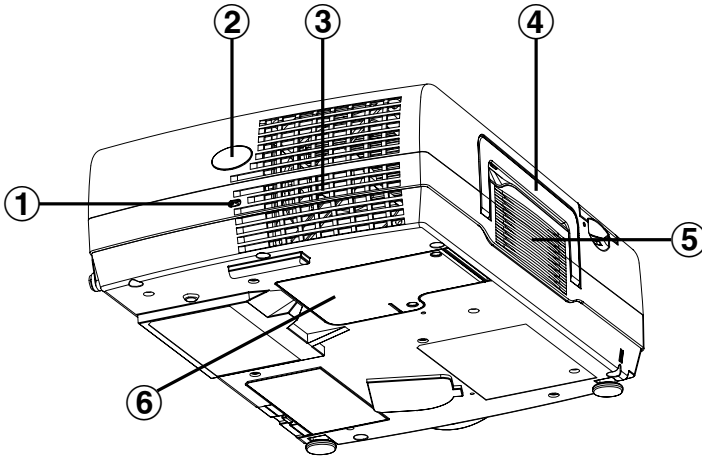
Projector <Back and bottom>**① Security lock**

This can be used to connect a commercially-available theft-prevention cable (manufactured by Kensington). This security lock is compatible with the Microsaver Security System from Kensington. Contact details for this company are given below.

Kensington Technology Group
 ACCO Brands Inc.
 2855 Campus Drive
 San Mateo, CA 94403 USA
 Tel (650)572-2700
 Fax (650)572-9675
<http://www.kensington.com/>
<http://www.gravis.com/>

NOTE:

- Information given above may be changed in future.

② Remote control signal receptor

(page 22)

③ Air outlet port

Do not cover this port.

④ Carrying handle**⑤ Speaker (R)****⑥ Lamp unit holder**
(page 56)**WARNING**

Do not bring your hands or other objects close to the air outlet port.

- Heated air comes out of the air outlet port. Do not bring your hands or face, or objects which cannot withstand heat close to this port, otherwise burns or damage could result.

NOTE:

- During projection of an image, the cooling fan will operate, emitting a small noise as it operates. Turning the lamp on or off will cause this noise to increase a little.
- By using the OPTION menu to set LAMP POWER to "LOW", the operating sound of the fan can be reduced. (Refer to page 46.)

Remote control unit

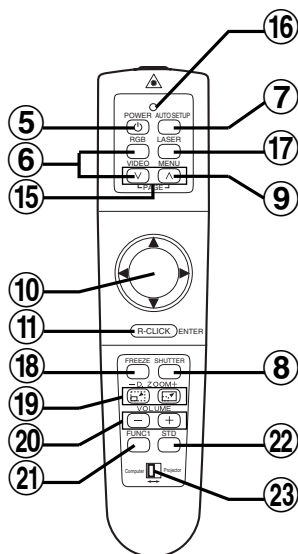
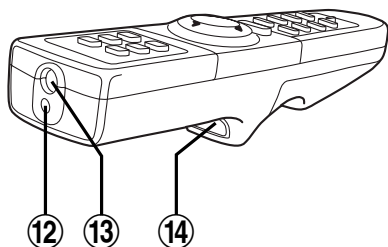

Projector control panel

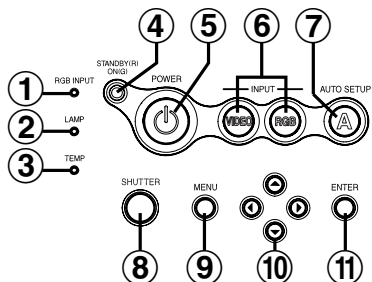

① RGB INPUT indicator

(page 26)

This indicator shows whether a signal is being input to the RGB input connectors (RGB 1 IN/RGB 2 IN). When an input signal is detected, the indicator illuminates.

② LAMP indicator

(page 53)

This indicator illuminates when it is time to replace the lamp unit. It flashes if a circuit abnormality is detected.

③ TEMP indicator

(page 52)

This indicator illuminates if an abnormally high or low temperature is detected inside the projector or around it. If the temperature reaches a certain level, the power supply will be turned off automatically and the indicator will flash.

④ Power indicator

(page 23, 25 and 26)

This indicator illuminates red when

the MAIN POWER switch is turned on (standby mode), and illuminates green when the power is turned on and a picture starts to be projected. When the WEB STANDBY is set to "ON", the cooling fan operates and the power indicator on the projector flashes slowly in red.

⑤ POWER button

(pages 23 and 25)

⑥ Input select (VIDEO, RGB) buttons

(page 24)

These buttons are used to select the input signals. When AUTO SEARCH in the OPTION menu is set to "ON", the input signal will be detected and selected automatically by pressing this button for a few seconds. (Refer to page 45.)

⑦ AUTO SETUP button

(pages 24 and 27)

If this button is pressed while a picture is being projected, the projection settings will be adjusted automatically in accordance with

the signal being input. In addition, the angle of tilt of the projector will be automatically detected and adjusted in order to correct any keystone distortion.

⑧ **SHUTTER button**
(page 28)

This button is used to momentarily turn off the picture and sound.

⑨ **MENU button**
(pages 32 and 35)

This button is used to display the menu screens. When a menu screen is being displayed, this button can be used to return to a previous screen or to clear the screen.

⑩ **Arrow (▲▼◀ and ▶) buttons**
(page 35)

These buttons are used to select and adjust items in the menu screens.

*When in computer operating mode, these buttons on the remote control unit function differently. (page 31)

⑪ **ENTER button**
(page 35)

This button is used to accept and to activate items selected in the on-screen menus.

*When in computer operating mode, this button on the remote control unit functions differently. (page 31)

⑫ **Laser emitter**
(page 30)

⑬ **Infrared emitter**
(page 22)

⑭ **Click button**
(page 31)

This button can be used when the operating mode select switch is moved to the left (Computer).

⑮ **PAGE button**
(page 31)

This button can be used when the operating mode select switch is moved to the left (Computer).

⑯ **Operation indicator**
(page 30)

This indicator illuminates while a laser beam is being emitted (while the LASER button is being pressed). It flashes when any other buttons are being pressed.

⑰ **LASER button**
(page 30)

A beam of laser light is emitted while this button is being pressed. This laser beam can be used as a pointer to point to something on the screen.

⑱ **FREEZE button**
(page 28)

This button is used to momentarily freeze projection so that a still picture is displayed.

⑲ **D.ZOOM +/- buttons**
(page 29)

These buttons are used to enlarge the projected image.

⑳ **VOLUME +/- buttons**
(page 29)

These buttons are used to adjust the volume of the sound that is output from the projector's built-in speaker and AUDIO OUT jack. Refer to page 44 for details on how to adjust the volume using the buttons on the projector control panel.

㉑ **FUNC1 (function) button**
(pages 41, 44 and 46)

This button can be used for 1) switching on and off the sound volume and 2) entering into the keystone distortion correction mode. Use the FUNC1 item in the OPTION menu to select which you wish to use.

㉒ **STD (standard) button**
(page 36)

This button is used to reset the projector adjustment values to the factory default settings.

㉓ **Operating mode (Computer, Projector) select switch**
(page 31)

Move this switch to the left side to use the remote control unit to operate a computer, and move it to the right side to operate the projector.

Connector panel

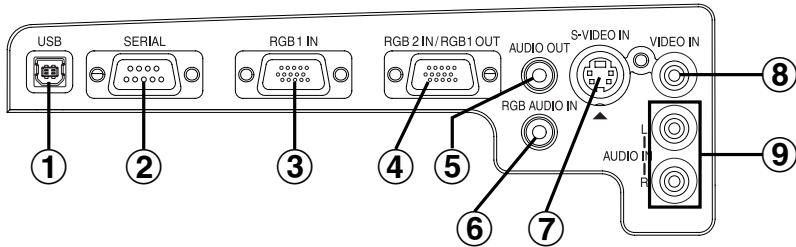

① **USB port**

(page 31)

The remote control unit can be used as a personal computer mouse by connecting the projector to a personal computer with the supplied USB cable. (4-pin square connector)

② **SERIAL connector**

(pages 20, 21 and 64)

This connector is used to connect a personal computer to the projector in order to externally control the projector. (RS-232C compatible)

③ **RGB1 IN connector**

(pages 20 and 21)

This connector is used to input RGB signals and YPBPR signals.

④ **RGB2 IN/RGB1 OUT connector**

(pages 20, 21 and 45)

This connector is used to input or output RGB signals and YPBPR signals. Use the RGB2 SELECT item in the OPTION menu to select whether you want input or output with this connector.

⑤ **AUDIO OUT jack**

(pages 20 and 21)

This jack is used to output the audio signals which are input to the projector. If audio equipment

is connected to this jack, no sound will be output from the built-in speaker.

⑥ **RGB AUDIO IN jack**

(pages 20 and 21)

Only one system is provided, so connect the appropriate connector when using RGB1 or RGB2.

⑦ **S-VIDEO IN connector**

(pages 20 and 43)

This connector is used to input signals from a S-VIDEO-compatible equipment such as a video deck. The connector is compatible with S2 and S1 signals, and projector aspect is automatically adjusted according to the type of signal received.

⑧ **VIDEO IN jack**

(page 20)

This jack is used to input video signals from a video equipment such as a video deck.

⑨ **AUDIO IN L-R (for VIDEO/S-VIDEO) jacks**

(page 20)

Only one system is provided, so connect the appropriate connector when using VIDEO or S-VIDEO.

(PT-L735NTU only)

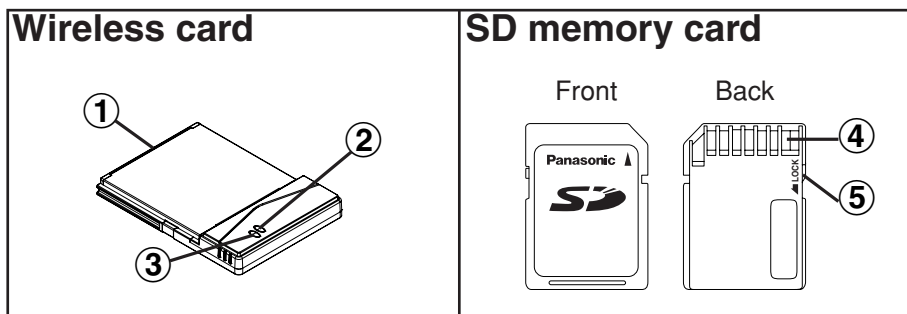

① Connector

This connector is for connecting the wireless card to the projector's card slot. Be careful not to touch the connector.

② Wireless card power indicator

Illuminates when the wireless card is operating.

③ Wireless card access indicator

Flashes while the projector is being accessed with personal computers by means of a wireless network.

④ Metal terminals

These terminals are for connecting the SD memory card to the projector's card slot. Do not touch the metal terminals with hands or metal objects, attach stickers to them, or allow them to become contaminated in any way.

⑤ Write-protect switch

If the write-protect switch on the SD memory card is moved to the LOCK position, it will not be possible to use any file editing functions such as deleting or moving image files.

Inserting the wireless card (PT-L735NTU only)

Insert the wireless card before using the PT-L735NTU.

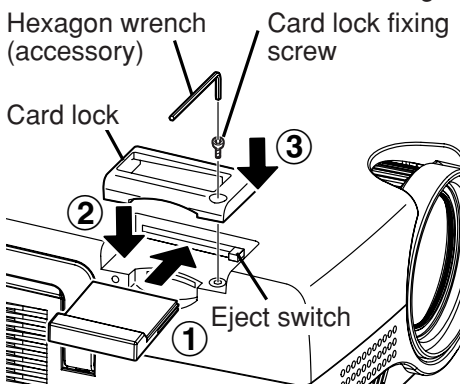

The card lock is already installed at the factory default setting. When you insert the wireless card, first remove the card lock fixing screw using the hexagon wrench to release the card lock.

- ① Insert the wireless card until it locks.
- ② Set the accessory card lock.
- ③ Fasten the card lock with the card lock fixing screw using the hexagon wrench.

- When removing the wireless card, remove the card lock, and then press the eject switch.

Setting-up

Projection methods

In way of installing projector, any one of the following four projection methods are used. Select whichever projection method matches the setting-up method. (The projection method can be set from the OPTION menu. Refer to page 46 for details.)

● Front-desk projection

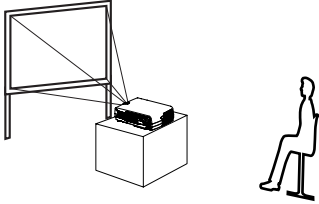

Menu items	Setting
FRONT/REAR	FRONT
DESK/CEILING	DESK

● Front-ceiling projection

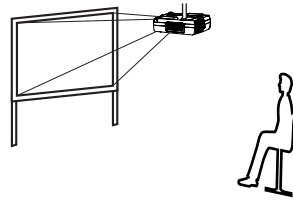

Menu items	Setting
FRONT/REAR	FRONT
DESK/CEILING	CEILING

● Rear-desk projection (Using a translucent screen)

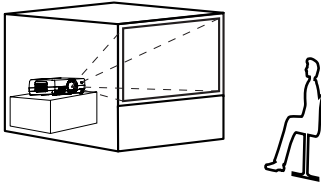

Menu items	Setting
FRONT/REAR	REAR
DESK/CEILING	DESK

● Rear-ceiling projection (Using a translucent screen)

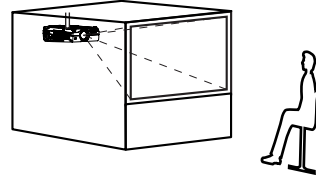

Menu items	Setting
FRONT/REAR	REAR
DESK/CEILING	CEILING

NOTE:

- You will need to purchase the separate ceiling bracket (ET-PK735) when using the ceiling installation method.
- If you set up the projector vertically, it may cause to damage the projector.
- It is recommended that you set up the projector in a place that is tilted at less than $\pm 30^\circ$. Setting up the projector in places that are tilted at more than $\pm 30^\circ$ may cause malfunctions.

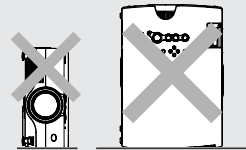

Projector position

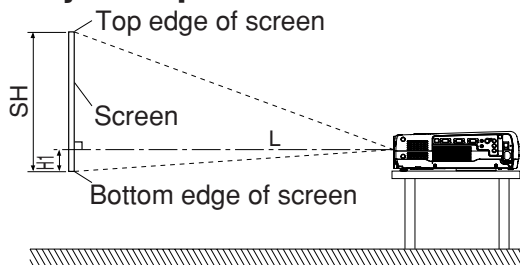

<Units: mm (inch)>

L: Projection distance
 SH: Image height
 SW: Image width
 H1: Distance from center of lens to bottom edge of projected image

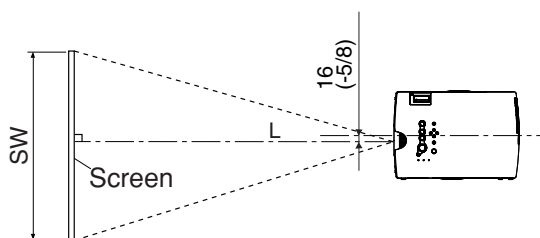

Getting started

Projection distances

Screen size (4:3)			Projection distance (L)		Height position (H1)
Diagonal length	Height (SH)	Width (SW)	Wide (LW)	Telephoto (LT)	
1.01 m(40")	0.61 m(2')	0.81 m(2'8")	1.2 m(3'11")	1.5 m(4'11")	0.06 m(2-13/32')
1.27 m(50")	0.76 m(2'6")	1.02 m(3'4")	1.6 m(5'2")	1.9 m(6'2")	0.08 m(3")
1.52 m(60")	0.91 m(3')	1.22 m(4')	1.9 m(6'2")	2.3 m(7'6")	0.09 m(3-19/32')
1.77 m(70")	1.07 m(3'6")	1.42 m(4'8")	2.2 m(7'2")	2.7 m(8'10")	0.11 m(4- 6/32')
2.03 m(80")	1.22 m(4')	1.63 m(5'4")	2.5 m(8'2")	3.1 m(10'2")	0.12 m(4-26/32')
2.28 m(90")	1.37 m(4'6")	1.83 m(6')	2.8 m(9'2")	3.5 m(11'5")	0.14 m(5-13/32')
2.54 m(100")	1.52 m(5')	2.03 m(6'8")	3.1 m(10'2")	3.9 m(12'9")	0.15 m(6")
3.81 m(150")	2.29 m(7'6")	3.05 m(10')	4.7 m(15'5")	5.8 m(19')	0.23 m(9")
5.08 m(200")	3.05 m(10')	4.06 m(13'4")	6.2 m(20'4")	7.8 m(25'7")	0.31 m(12")
6.35 m(250")	3.81 m(12'6")	5.08 m(16'8")	7.8 m(25'7")	9.8 m(32'1")	0.38 m(15")
7.62 m(300")	4.57 m(15')	6.10 m(20')	9.4 m(30'10")	11.8 m(38'8")	0.46 m(18")

NOTE:

- The dimensions in the table above are approximate.
- If you use the projection distance for the 16:9 screen, the 4:3 projection image overflows the screen at the top and bottom.
- For details about projected image distances, refer to page 63.

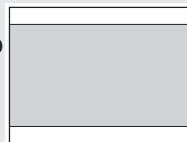

Connections

Notes on connections

- Read the instruction manual for each system component carefully before connecting it.
- Turn off the power supply for all components before making any connections.
- If the cables necessary for connecting a component to the system are not included with the component or available as an option, you may need to fashion a cable to suit the component concerned.
- If there is a lot of jitter in the video signal which is input from the video source, the picture on the screen may flicker. In such cases, it will be necessary to connect a TBC (time base corrector).
- Refer to the list on page 62 for details on compatible signals which can be input to the projector.
- Only one audio system circuit is available for each of the AUDIO IN L-R jacks for S-VIDEO/VIDEO signals and the RGB AUDIO IN jack, so if you wish to change the audio input source, you will need to remove and insert the appropriate plugs.

Example of connecting to video equipments

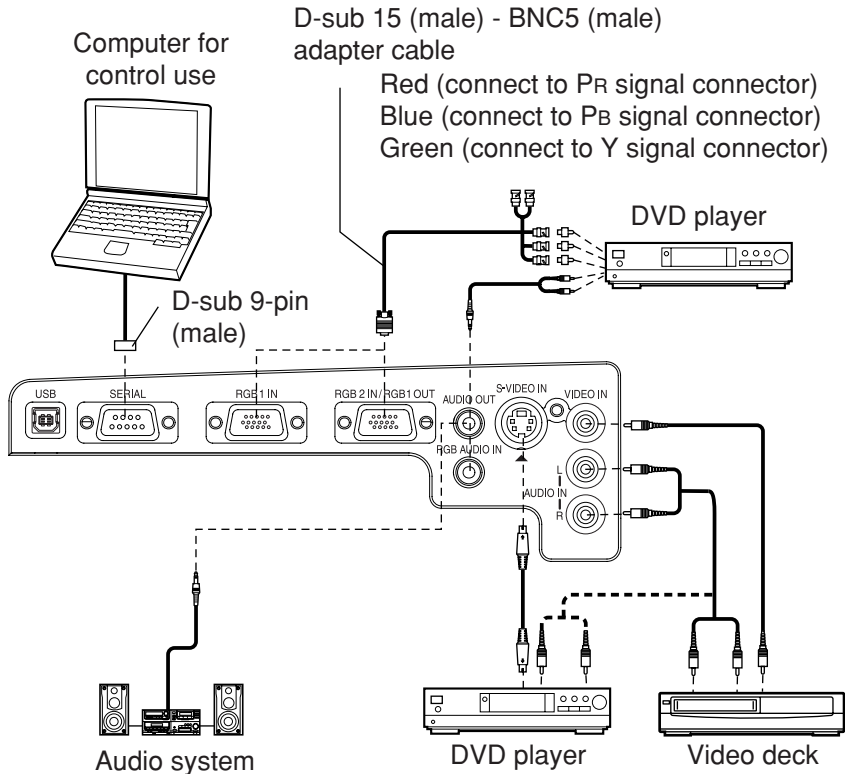

NOTE:

- If the video signal source is connected using a cable with a BNC connector plug, use a BNC/RCA adapter (sold separately) to convert the cable end to an RCA plug-type jack.
- If the signal cables are disconnected or if the power supply for the computer or video deck is turned off while the digital zoom function is being used, this function will be cancelled.

Example of connecting to computer

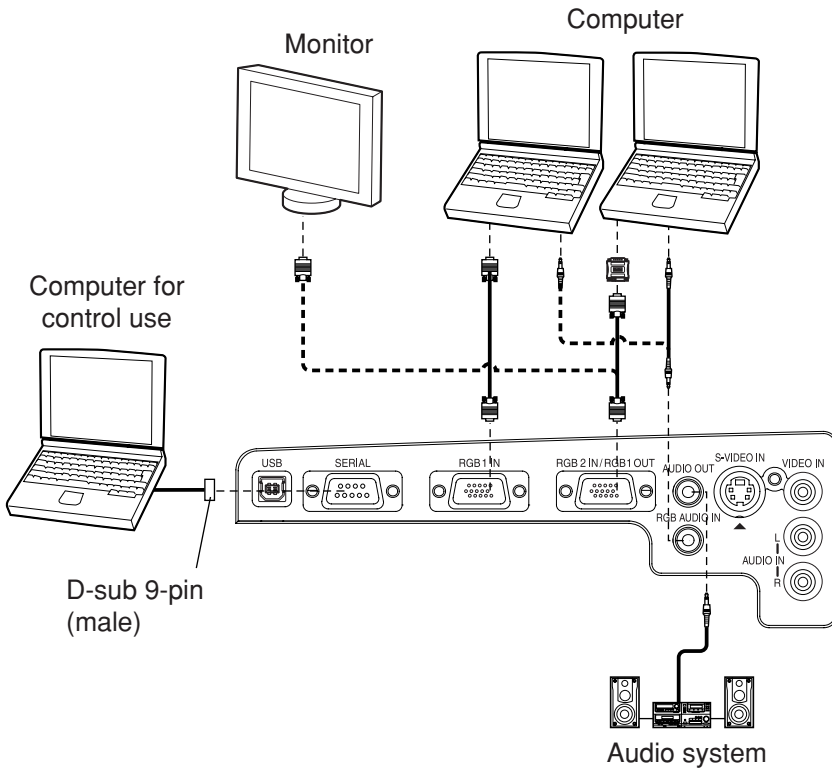

NOTE:

- It is better to shut down the computer before turning off the MAIN POWER switch of the projector.
- Do not input the signal to the RGB2 IN/RGB1 OUT connector when the RGB2 SELECT item in the OPTION menu is set to "OUTPUT". (Refer to page 45.)

Refer to the accessory CD-ROM for details on the wireless network that is used for controlling the projector with a personal computer by means of the wireless card. (PT-L735NTU only)

Preparation for the remote control unit

① Open the cover.

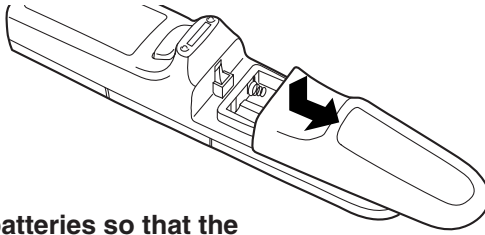

② Insert the batteries so that the polarities are correct, and then close the cover.

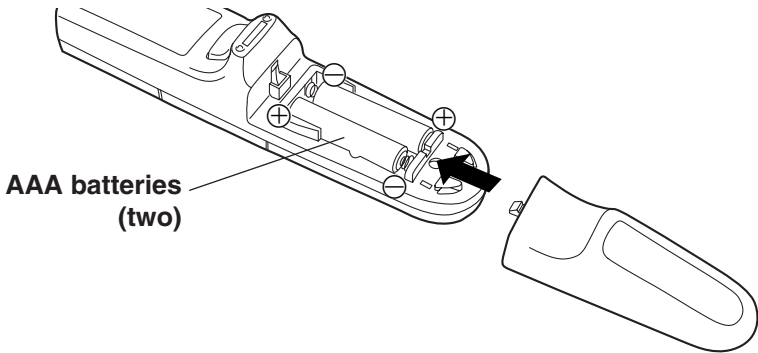

NOTE:

- Do not drop the remote control unit.
- Keep the remote control unit away from liquids.
- Remove the batteries if not using the remote control unit for long periods.
- Do not use rechargeable batteries.

Operating range

If the remote control unit is held so that it is facing directly in front of the remote control signal receptors on the front or rear of the projector, the operating range is within approximately 7 m (23') from the surfaces of the receptors. Furthermore, the remote control unit can be operated from an angle of $\pm 30^\circ$ to the left or right and $\pm 15^\circ$ above or below the receptors.

NOTE:

- If there are any obstacles in between the remote control unit and the receptors, the remote control unit may not operate correctly.
- If strong light is allowed to shine onto the remote control signal receptor, correct projector operation may not be possible. Place the projector as far away from light sources as possible.
- If facing the remote control unit toward the screen to operate the projector, the operating range of the remote control unit will be limited by the amount of light reflection loss caused by the characteristics of the screen used.

Turning on the power

Before turning on the power

- 1, Ensure that all components are connected properly.
- 2, Connect the accessory power cord.
- 3, Remove the lens cover.

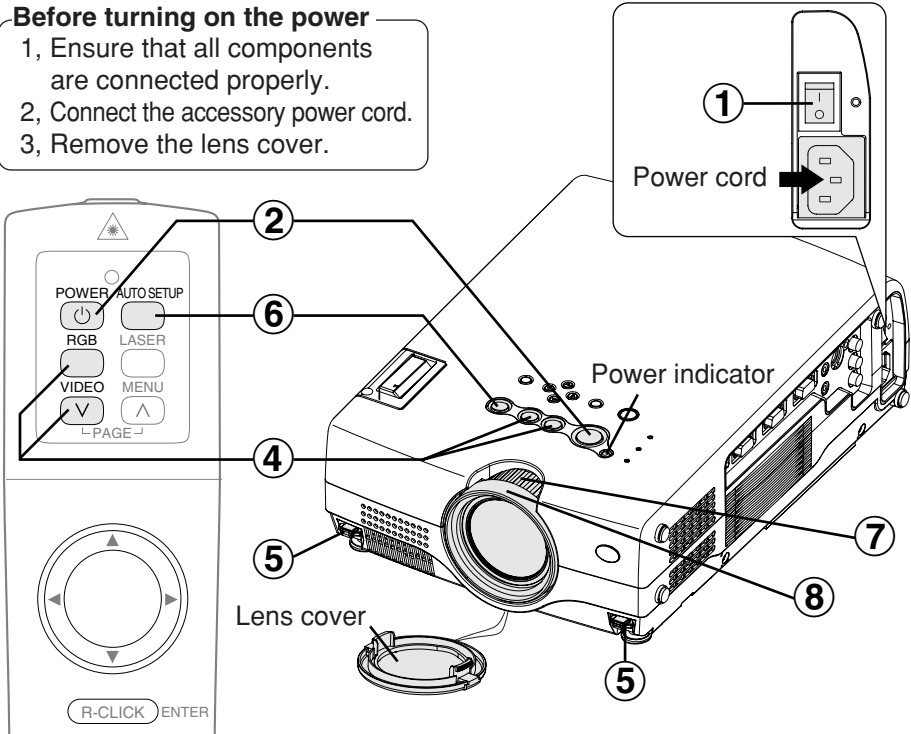

- 1 Press the MAIN POWER switch to turn on the power.**
 - The power indicator on the projector will illuminate red.
- 2 Press the POWER button.**
 - The power indicator on the projector will flash green. After a short period, the indicator will illuminate green, and a picture will be projected.
- 3 Turn on the power of all connected devices.**
 - Start the play function of a device such as a DVD player.

NOTE:

- A tinkling sound may be heard while the power indicator is turned off, but this is not a sign of a malfunction.

4 Press the input select button to select the input signal.

Input select buttons	VIDEO VIDEO VIDEO V	RGB RGB RGB	PT-L735NTU only RGB RGB RGB
Changing signals	VIDEO ↕ S-VIDEO	RGB1 ↕ RGB2	RGB1 → RGB2 ↑ SDCARD ← NETWORK

- A picture will be projected in accordance with the selected input signal.

Follow the procedure below when you set the projector up first, and when you change the setup place.

5 Adjusting the angle

- While pressing the adjuster buttons, adjust the forward/back angle of the projector. Adjust so that the projector is as vertical to the screen as possible.

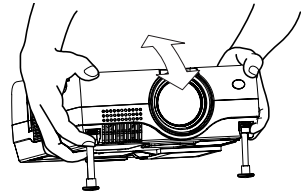

6 Press the AUTO SETUP button to initiate automatic positioning.

- The tilt of the projector and the input signal will be detected and keystone distortion and the position of the image will be corrected. (Refer to page 27 for details.)



7 Adjusting the size

- Turn the zoom ring to adjust the size of the projected image.

8 Adjusting the focus

- Turn the focus ring to adjust the focus of the projected image.

Turning off the power

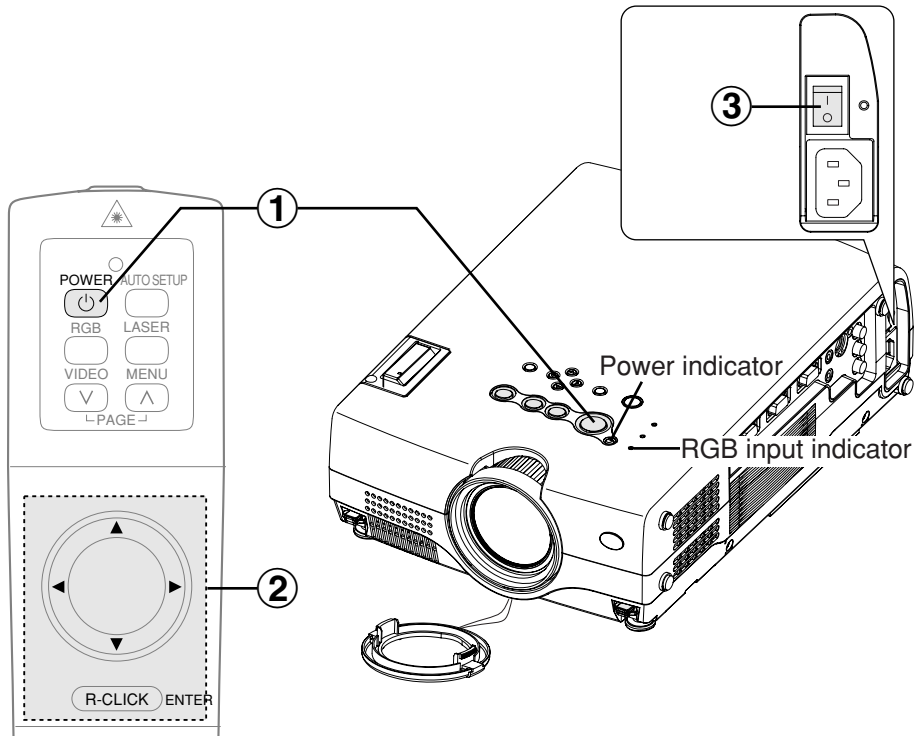

1 Press the POWER button.

- “Power OFF” is displayed on the screen.



2 Select “OK” using the ◀ and ▶ buttons and then press the ENTER button.

- The lamp unit will switch off and the picture will stop being projected. (The power indicator on the projector will illuminate orange.)

3 Press the MAIN POWER switch to turn off the power after the power indicator on the projector illuminates red.

Direct power off function

You can turn off the MAIN POWER switch and move the projector immediately after use. The cooling fan will operate by the internal power supply to cool down the lamp.

- When this function is used, it may take more time for the lamp to turn back on again compared to when the lamp cools down while the MAIN POWER switch is ON.
- Do not put the projector in a bag while the cooling fan is operating.

NOTE:

- You can also turn off the power by pressing the POWER button twice or by holding down it for at least 0.5 seconds.
- When the projector is in standby mode (the power indicator on the projector is illuminated red), the projector will still draw a maximum 7 W of power, even when the cooling fan has stopped.

(PT-L735NTU only)

- When the WEB STANDBY is set to “ON”, the cooling fan operates and the power indicator on the projector flashes slowly in red and the projector draw a maximum 30 W of power. (page 48)
- Do not turn off the power while the SD card is being accessed and “SD CARD IN USE.” is displayed on the screen.

Power indicator

Power indicator status		Projector status
Red	Illuminated	The projector is in standby mode and image projection is possible by pressing the POWER button.
	Flashing slowly	WEB STANDBY in the NETWORK menu is set to “ON”. The projector can be controlled with personal computers by means of a wireless network. (The cooling fan is operating.) : PT-L735NTU only.
Green	Flashing	The projector is preparing for projection after the power is turned on while the power indicator is illuminated red. (After a short period, a picture will be projected.)
	Illuminated	A picture is being projected.
Orange	Illuminated	The lamp is cooling down after the power is turned off. (The cooling fan is operating.)
	Flashing	The projector is preparing for projection after the power is turned on while the power indicator is illuminated orange. (After a short period, a picture will be projected.)

RGB INPUT indicator

RGB INPUT indicator status	Projector status
Illuminated during standby mode	A signal is being input to either the RGB1 IN or RGB2 IN connector.
Illuminated during projection	A signal is being input to the connector selected using the input select buttons.

Correcting keystone distortion and automatic positioning (AUTO SETUP)

This projector detects its degree of tilt and the input signal. Keystone distortion and the position of the image can then be corrected automatically in accordance with the input signal.

Press the AUTO SETUP button.

(When the projected image has caused keystone distortion)

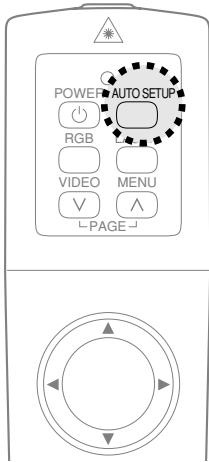

Projector control panel

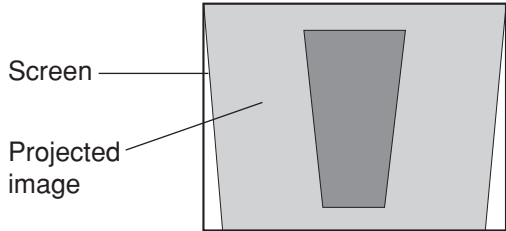
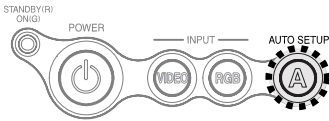

- Automatic positioning will be carried out.

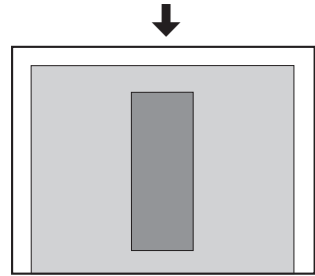

If you press the AUTO SETUP button, the items given in the table below will be set automatically in addition to keystone distortion being corrected. The setting details change according to the signal which is being input.

Input signal	Contents set up automatically	Page
RGB signals	POSITION, DOT CLOCK, CLOCK PHASE (If the dot clock frequency is 100 MHz or higher, the DOT CLOCK and CLOCK PHASE will not be set automatically.)	40, 41

NOTE:

- If the edges of the projected picture are indistinct, or if a dark picture is being projected, the automatic setup processing may stop automatically before it is complete. If this happens, project a different picture and then press the AUTO SETUP button once more, or make the above adjustments manually.
- Set AUTO KEYSTONE in the OPTION menu to "OFF" to prevent any deterioration of the picture as a result of keystone correction. (Refer to page 45.)
- Keystone distortion may not be corrected enough depending on the adjustment of the zoom ring. In this case, adjust the KEYSTONE option. (Refer to page 41.)

Turning off the picture and sound momentarily (SHUTTER)

The shutter function can be used to momentarily turn off the picture and sound from the projector when the projector is not being used for short periods of time, such as during breaks in meetings or when carrying out preparation. The projector uses less power in shutter mode than it does in normal projection mode.

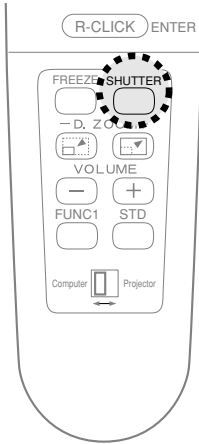

Press the SHUTTER button.

- The picture and sound will be turned off.
- Press any button on either the projector or remote control unit to return to normal operating mode.

Pausing a picture (FREEZE)

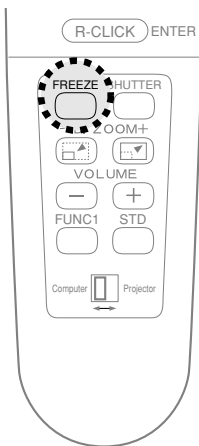

Press the FREEZE button.

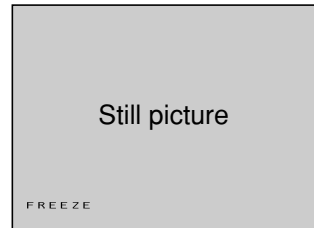

- The picture being projected will be paused.
- Press the FREEZE button again to cancel the still picture.

Enlarging the picture (D.ZOOM)

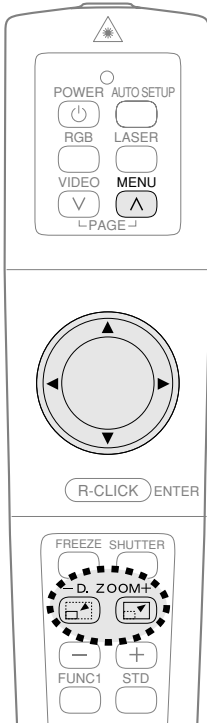

Press a D.ZOOM +/- button.

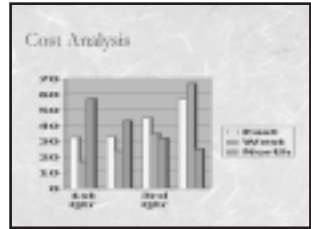

- The picture will then be enlarged to 1.5 times the normal size.

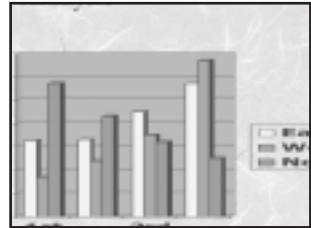

The remote control unit functions during D.ZOOM (digital zoom)

Use the ▲, ▼, ◀ and ▶ buttons to move the enlarged area which you want to project.

Use the D.ZOOM +/- buttons to change the enlargement ratio.

Press the MENU button to return to the normal screen.

NOTE:

- The enlargement ratio can be changed within the range of x1 to x4, by 30 steps.
- If the type of signal being input changes while the digital zoom function is being used, the digital zoom function will be cancelled.

Adjusting the volume (VOLUME)

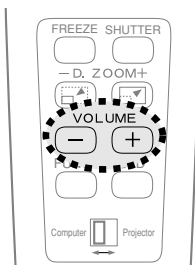

Press the VOLUME +/- button.

- Press the + button to raise the volume.
- Press the - button to lower the volume.

NOTE:

- You can also select "VOLUME" from the AUDIO menu to adjust the volume.

Useful functions of the remote control unit

Laser beam pointer

The laser beam emitted from the remote control can be used as a pointer by pointing forward to the screen.

While the LASER button is being pressed, the laser beam is being emitted and the operating indicator illuminates.

Do not look into the laser emitter of the remote control unit or point the laser beam towards other people, otherwise damage to eyes may occur.

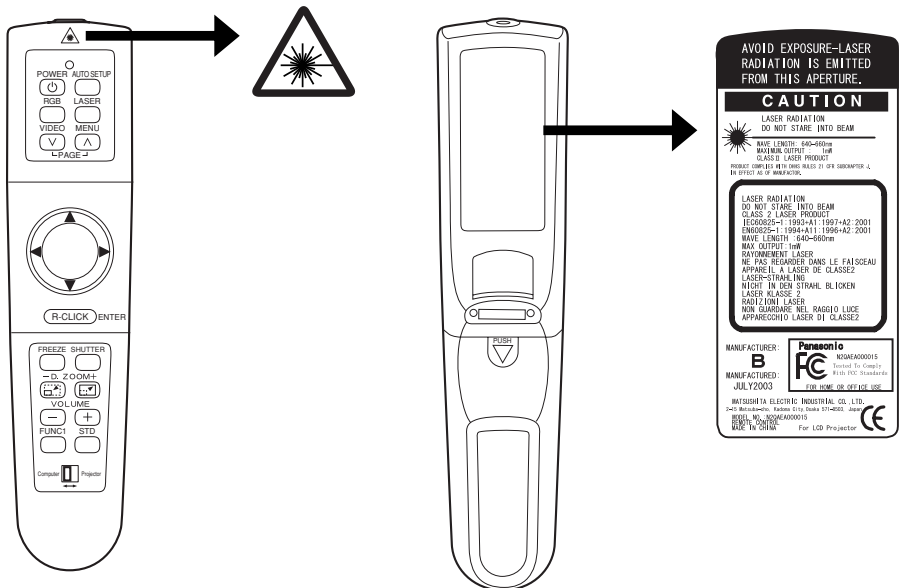
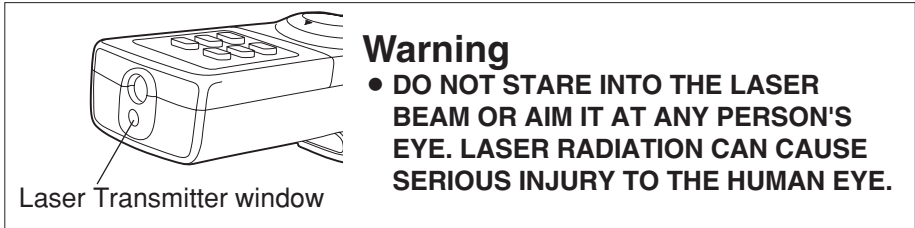

Caution

- Use of controls or adjustments or performance of procedures other than those specified herein may result in hazardous radiation exposure.
- This remote control unit cannot be repaired.

Wireless mouse

You can use the remote control as a personal computer mouse. Set the Mode (Projector/Computer) switch on the remote control unit to “Computer” and connect the projector’s USB port to a personal computer counterpart with the accessory USB cable.

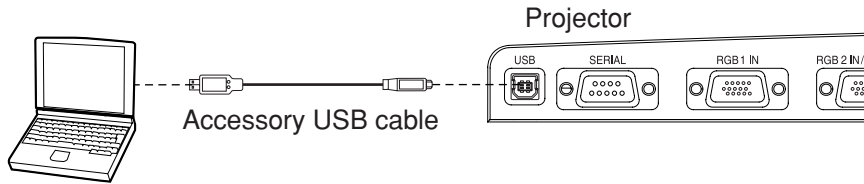

Computer equipped with a USB port

- For Windows (Versions 98SE, Me, 2000 and XP), you can use the standard mouse driver which comes bundled with the operating system.

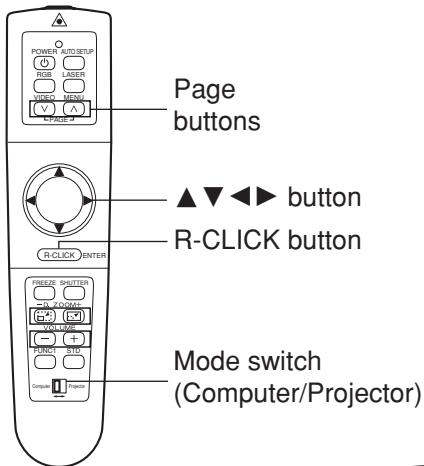

Mode switch (Computer/Projector)
Move the mode switch to the “Computer” position.

- **Page buttons**

^: Functions as the Page Up button on a personal computer keyboard.

v: Functions as the Page Down button on a personal computer keyboard.

- **Arrow (▲▼◀▶) buttons**

These buttons can move the cursor on a personal computer’s screen as the personal computer mouse.

- **R-CLICK button**

This button functions as the right button on a personal computer mouse.

- **Click button**

This button functions as the left button on a personal computer mouse.

NOTE:

- The optional wireless mouse receiver (ET-RMRC2) is needed when the projector and personal computers are placed where they cannot be connected with the accessory USB cable.

On-screen menus

Menu screens

The various settings and adjustments for this projector can be carried out by selecting the operations from on-screen menus.

The general arrangement of these menus is shown below.

PICTURE menu (page 37)

When an RGB signal is being input

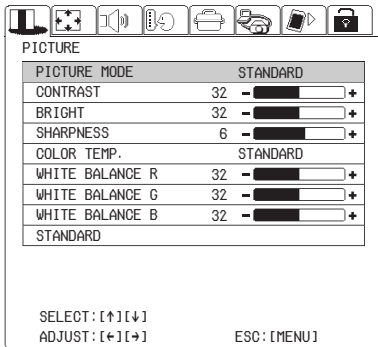

When a YPbPr signal is being input

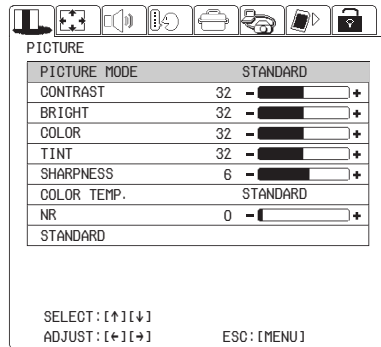

When an S-VIDEO/VIDEO signal is being input

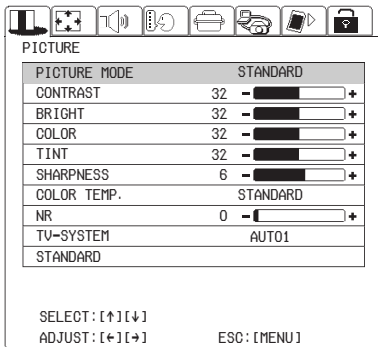

When the NETWORK/SD CARD is selected. (PT-L735NTU only)

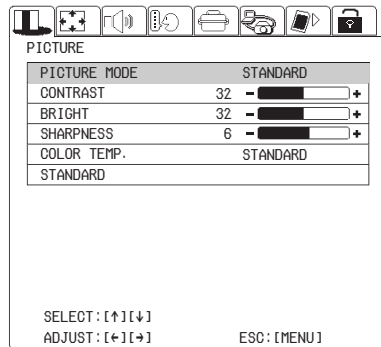

NOTE:

- The onscreen displays in these operating instructions are for the PT-L735NTU.
- Keystone distortion of the on-screen display will not be corrected.

POSITION menu (page 40)

When an RGB signal is being input



POSITION		
POSITION	H: 128	V: 32
DOT CLOCK	32	<input type="range"/>
CLOCK PHASE	16	<input type="range"/>
KEYSTONE	H: 0	V: 0
OSD POSITION	TOP LEFT	
RESIZING	OFF	ON
AUTO SETUP		
FRAME LOCK	OFF	ON
STANDARD		

SELECT: [↑][↓] ENTER: [ENTER]
ESC: [MENU]

When a YPbPr signal is being input



POSITION		
POSITION	H: 64	V: 16
KEYSTONE	H: 0	V: 0
OSD POSITION	TOP LEFT	
ASPECT	4:3	
RESIZING	OFF	ON
AUTO SETUP		
STANDARD		

SELECT: [↑][↓] ENTER: [ENTER]
ESC: [MENU]

When an S-VIDEO/VIDEO signal is being input



POSITION		
POSITION	H: 32	V: 16
KEYSTONE	H: 0	V: 0
OSD POSITION	TOP LEFT	
ASPECT	AUTO	
RESIZING	OFF	ON
AUTO SETUP		
STANDARD		

SELECT: [↑][↓] ENTER: [ENTER]
ESC: [MENU]

When the NETWORK/SD CARD is selected (PT-L735NTU only)



POSITION		
KEYSTONE	H: 0	V: 0
OSD POSITION	TOP LEFT	
AUTO SETUP		
STANDARD		

SELECT: [↑][↓] ENTER: [ENTER]
ESC: [MENU]

AUDIO menu (page 44)



AUDIO		
VOLUME	20	<input type="range"/>
MUTE	OFF	ON
AUDIO MODE	VOICE	NORMAL

SELECT: [↑][↓] ENTER: [ENTER]
ADJUST: [←][→] ESC: [MENU]

LANGUAGE menu (page 44)



LANGUAGE		
ENGLISH	ESPAÑOL	日本語
DEUTSCH	ITALIANO	中文
FRANÇAIS	РУССКИЙ	조선어

SELECT: [↑][↓] ESC: [MENU]
SELECT: [←][→] ENTER: [ENTER]

OPTION menu (page 45)

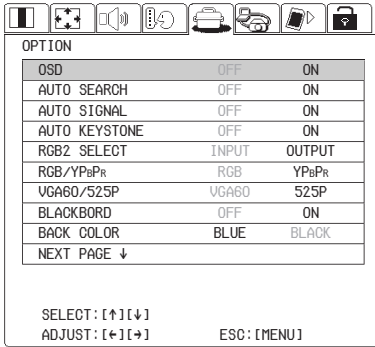

OPTION

OSD	OFF	ON
AUTO SEARCH	OFF	ON
AUTO SIGNAL	OFF	ON
AUTO KEYSTONE	OFF	ON
RGB2 SELECT	INPUT	OUTPUT
RGB/YPbPr	RGB	YPbPr
VGA60/525P	VGA60	525P
BLACKBORD	OFF	ON
BACK COLOR	BLUE	BLACK
NEXT PAGE ↓		

SELECT: [↑][↓]
ADJUST: [←][→] ESC: [MENU]

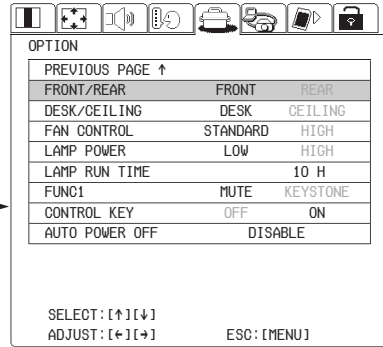

OPTION

PREVIOUS PAGE ↑		
FRONT/REAR	FRONT	REAR
DESK/CEILING	DESK	CEILING
FAN CONTROL	STANDARD	HIGH
LAMP POWER	LOW	HIGH
LAMP RUN TIME		10 H
FUNC1	MUTE	KEYSTONE
CONTROL KEY	OFF	ON
AUTO POWER OFF		DISABLE

SELECT: [↑][↓]
ADJUST: [←][→] ESC: [MENU]

The RGB/YPbPr item is displayed when an RGB/YPbPr signal is being input.

NETWORK menu (page 48) (PT-L735NTU only)

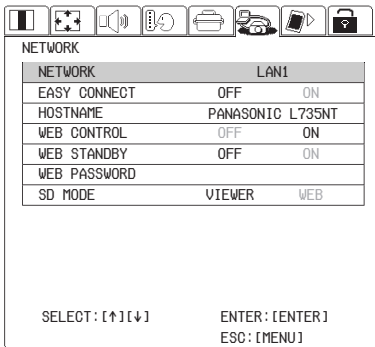

NETWORK

NETWORK		LAN1
EASY CONNECT	OFF	ON
HOSTNAME	PANASONIC L735NT	
WEB CONTROL	OFF	ON
WEB STANDBY	OFF	ON
WEB PASSWORD		
SD MODE	VIEWER	WEB

SELECT: [↑][↓] ENTER: [ENTER]
ESC: [MENU]

SD CARD menu (page 48) (PT-L735NTU only)

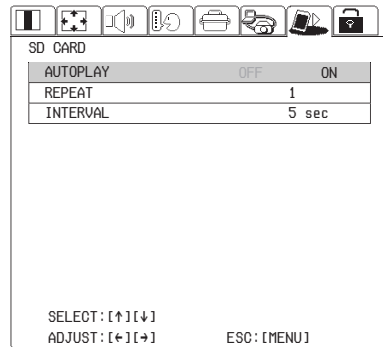

SD CARD

AUTOPLAY	OFF	ON
REPEAT	1	
INTERVAL	5 sec	

SELECT: [↑][↓]
ADJUST: [←][→] ESC: [MENU]

SECURITY menu (page 49)

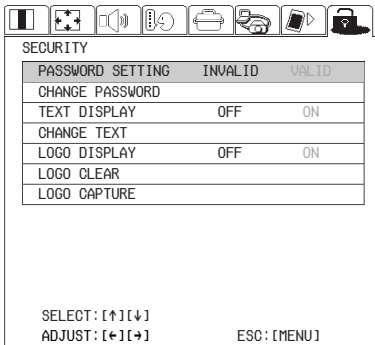

SECURITY

PASSWORD SETTING	INVALID	VALID
CHANGE PASSWORD		
TEXT DISPLAY	OFF	ON
CHANGE TEXT		
LOGO DISPLAY	OFF	ON
LOGO CLEAR		
LOGO CAPTURE		

SELECT: [↑][↓]
ADJUST: [←][→] ESC: [MENU]

Menu operation guide

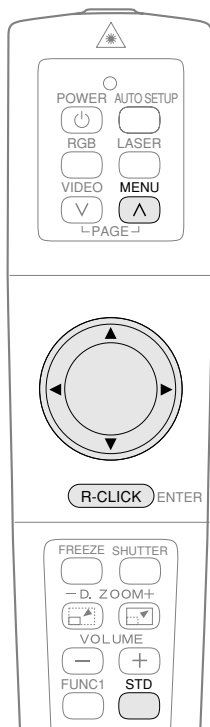

Projector control panel



NOTE:

- Press the MENU button to return to the previous screen.

① Press the MENU button.

The menu screen will be displayed.

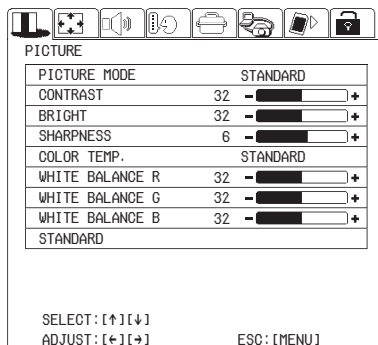

② Press the ◀ or ▶ arrow buttons to select a menu.

The selected menu screen will then be displayed.
(Example: POSITION menu)

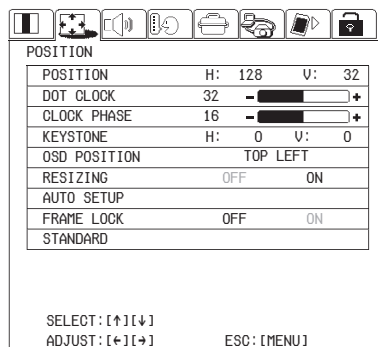

③ Press the ▼ arrow button to accept the selection.

You can select an item here. The selected item is shown in yellow.

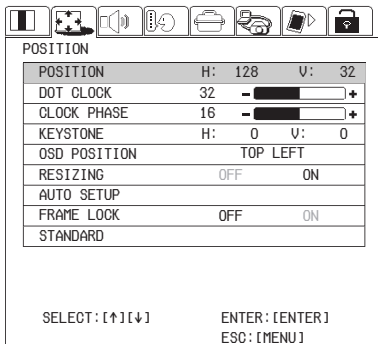

④ Select an item pressing the ▲ or ▼ buttons.

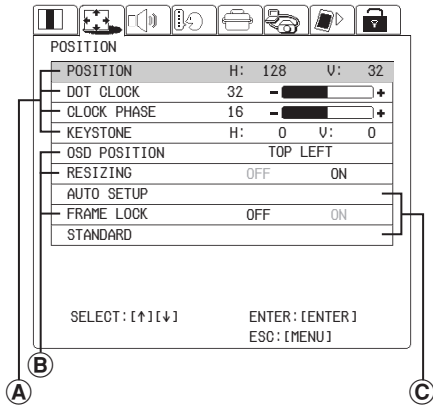

① For the value adjusting items Press the ENTER button to display an individual adjustment screen.

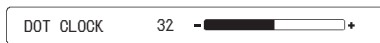
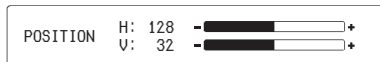

Press the ◀ or ▶ buttons to adjust the setting.

You can also adjust the bar-scale items pressing the ◀ or ▶ buttons in the menu screen.

Some items can be adjusted by pressing the ▲ or ▼ buttons.

② For the selective items



Select the setting by pressing the ◀ or ▶ buttons.

③ For the fixed items

Press the ENTER button, and the function will work.

Returning a setting to the factory default

If you press the STD (standard) button on the remote control unit, you can return settings to the factory default settings. However, the operation of this function varies depending on which screen is being displayed.

- When a menu screen is being displayed

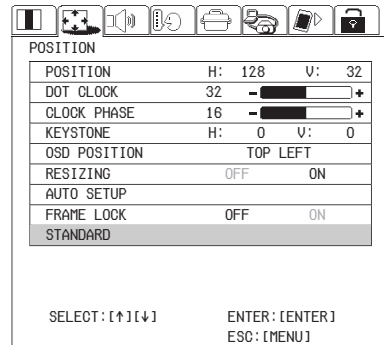

All items displayed will be returned to their factory default settings.

NOTE:

- You can also select STANDARD from the menu screen and then press the ENTER button.

- When an individual adjustment screen is being displayed



Only the item displayed will be returned to the factory default setting.

Adjusting the picture

Select the item pressing the ▲ or ▼ buttons on the remote control unit or the projector.

Press the ◀ or ▶ buttons to set the selective items. For the value adjusting items, press the ENTER button to display an individual screen, and press the ◀ or ▶ buttons to adjust the setting.

When an RGB signal is being input

PICTURE	
PICTURE MODE	STANDARD
CONTRAST	32
BRIGHT	32
SHARPNESS	6
COLOR TEMP.	STANDARD
WHITE BALANCE R	32
WHITE BALANCE G	32
WHITE BALANCE B	32
STANDARD	

SELECT: [↑][↓]
ADJUST: [←][→] ESC: [MENU]

When a YPBPR signal is being input

PICTURE	
PICTURE MODE	STANDARD
CONTRAST	32
BRIGHT	32
COLOR	32
TINT	32
SHARPNESS	6
COLOR TEMP.	STANDARD
NR	0
STANDARD	

SELECT: [↑][↓]
ADJUST: [←][→] ESC: [MENU]

When an S-VIDEO/VIDEO signal is being input

PICTURE	
PICTURE MODE	STANDARD
CONTRAST	32
BRIGHT	32
COLOR	32
TINT	32
SHARPNESS	6
COLOR TEMP.	STANDARD
NR	0
TV-SYSTEM	AUTO1
STANDARD	

SELECT: [↑][↓]
ADJUST: [←][→] ESC: [MENU]

When the NETWORK/SD CARD is selected

PICTURE	
PICTURE MODE	STANDARD
CONTRAST	32
BRIGHT	32
SHARPNESS	6
COLOR TEMP.	STANDARD
STANDARD	

SELECT: [↑][↓]
ADJUST: [←][→] ESC: [MENU]

PICTURE MODE

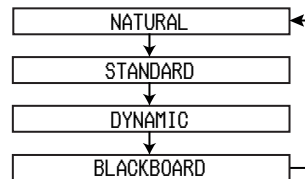

Select the picture mode that best matches the image source and room conditions. The mode best used in dark rooms is NATURAL. For rooms having regular lighting conditions in use, select STANDARD. For exceptionally bright rooms, use DYNAMIC. BLACKBOARD is available only when BLACKBOARD in the OPTION menu is set to "ON". Select BLACKBOARD when projecting onto blackboards.

CONTRAST

This adjusts the contrast of the picture. Press the ► button to make the picture brighter, and press the ◀ button to make the picture darker. (Adjust the BRIGHT setting first if required before adjusting the CONTRAST setting.)

BRIGHT

This adjusts the darker areas (black areas) in the picture. Press the ► button if dark areas are too solid (for example, if hair is difficult to see), and press the ◀ button if black areas are too light (grey rather than black).

COLOR

(S-VIDEO/VIDEO/YPbPr only)
Press the ► button to make the color more vivid in tone, and press the ◀ button to make the color more pastel in tone.

TINT

(NTSC/NTSC 4.43/YPbPr only)
This adjusts the flesh tones in the picture. Press the ► button to make flesh tones more greenish, and press the ◀ button to make the flesh tones more reddish.

SHARPNESS

Press the ► button to make the picture details sharper, and press the ◀ button to make the picture details softer.

Color Hue Setting (COLOR TEMP.)



This is used to adjust the white areas of the picture if they appear bluish or reddish.

Noise Reduction (NR)

(When S-VIDEO/VIDEO/YPbPr signals are being input)
If the signal is of such poor quality that picture interference appears, you can suppress this interference by adjusting the NR (Noise Reduction). To strengthen the effect, press the ► button. To turn it off, set to "0" by pressing the ◀ button.

WHITE BALANCE R/G/B

(RGB only)
This is used to adjust the white areas of the picture if they appear colorised. Press the ◀ button to make the selected color lighter. Press the ► button to make the selected color stronger.

TV-SYSTEM

(S-VIDEO/VIDEO only)

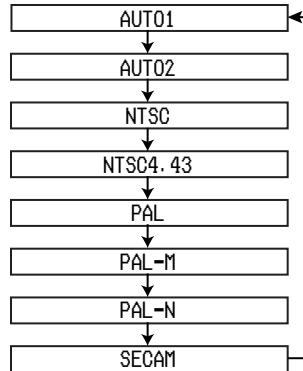

AUTO1

The projector automatically distinguishes between NTSC/NTSC 4.43/PAL/PAL60/SECAM signals.

AUTO2

The projector automatically distinguishes between NTSC/PAL-M/PAL-N signals.

NOTE:

- This should normally be set to “AUTO1” or “AUTO2”. If the signal is of such poor quality that the correct format cannot be automatically distinguished, change the setting manually to the required TV system.

Projecting sRGB-compatible pictures

sRGB is an international color reproduction standard (IEC61966-2-1) established by the International Electrotechnical Commission (IEC). If you would like the colors in sRGB-compatible pictures to be reproduced more faithfully, make the following settings.

- ① Press the ▲ or ▼ button to select “PICTURE MODE”, and then use the ◀ or ▶ button to select “NATURAL”.
- ② Press the ▲ or ▼ button to select “COLOR TEMP.”, and then use the ◀ or ▶ button to select “STANDARD”.
- ③ Press the STD (standard) button on the remote control unit.
- ④ Select the LAMP POWER item in the OPTION menu by pressing the ▲ or ▼ buttons and set to “HIGH” by pressing the ◀ or ▶ buttons.

NOTE:

- sRGB is only enabled when RGB signals are being input .

Adjusting the position

When the input signal is RGB, first press the AUTO SETUP button to initiate automatic positioning. If the optimum setting is not obtained when AUTO SETUP is carried out, adjust by the following procedure.

Select the item pressing the ▲ or ▼ buttons on the remote control unit or the projector.

Press the ◀ or ▶ buttons, to adjust the alternative items. For the numerically adjustable items, press the ENTER button to display an individual screen, and press the ◀ or ▶ buttons to adjust the setting. Some items can be adjusted pressing the ▲ or ▼ buttons.

When an RGB signal is being input



POSITION		
POSITION	H: 128	V: 32
DOT CLOCK	32	— [] +
CLOCK PHASE	16	— [] +
KEYSTONE	H: 0	V: 0
OSD POSITION	TOP LEFT	
RESIZING	OFF	ON
AUTO SETUP		
FRAME LOCK	OFF	ON
STANDARD		

SELECT: [↑][↓] ENTER: [ENTER]
ESC: [MENU]

When a YPbPr signal is being input.



POSITION		
POSITION	H: 64	V: 16
KEYSTONE	H: 0	V: 0
OSD POSITION	TOP LEFT	
ASPECT	4:3	
RESIZING	OFF	ON
AUTO SETUP		
STANDARD		

SELECT: [↑][↓] ENTER: [ENTER]
ESC: [MENU]

When an S-VIDEO/VIDEO signal is being input



POSITION		
POSITION	H: 32	V: 16
KEYSTONE	H: 0	V: 0
OSD POSITION	TOP LEFT	
ASPECT	AUTO	
RESIZING	OFF	ON
AUTO SETUP		
STANDARD		

SELECT: [↑][↓] ENTER: [ENTER]
ESC: [MENU]

When the NETWORK/SD CARD is selected



POSITION		
KEYSTONE	H: 0	V: 0
OSD POSITION	TOP LEFT	
AUTO SETUP		
STANDARD		

SELECT: [↑][↓] ENTER: [ENTER]
ESC: [MENU]

POSITION

Moves the picture position.

Press the ◀ or ▶ buttons to move the picture horizontally.

Press the ▲ or ▼ buttons to move the picture vertically.

POSITION	H: 128	— [] +
	V: 32	— [] +

DOT CLOCK

(RGB only)

Periodic striped pattern interference (noise) may occur when a striped pattern such as the one below is projected. If this happens, use the ◀ and ▶ buttons to adjust so that any such noise is minimised.

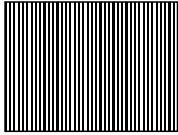

CLOCK PHASE

(RGB only)

Adjust the DOT CLOCK setting first before carrying out this adjustment. Use the ◀ and ▶ buttons to adjust so that the noise level is least noticeable.

NOTE:

- If signals with a dot clock frequency of 100 MHz or higher are being input, interference may not be completely eliminated when the DOT CLOCK and CLOCK PHASE adjustments are carried out.

KEYSTONE

Before carrying out keystone correction, 1) adjust the forward/back angle of tilt of the projector by pressing the adjuster buttons and 2) press the AUTO SETUP buttons to correct vertical keystone distortion. (page 27)

The vertical keystone distortion will be automatically corrected by the projectors automatic setup function. However the horizontal distortion needs to be corrected or a tilted screen needs to be adjusted manually by following any of the procedures in the table.

KEYSTONE H: 0 U: 0

Picture condition	Operation
	Press the ▲ button.
	Press the ▼ button.
	Press the ◀ button.
	Press the ▶ button.

NOTE:

- If you press the AUTO SETUP button after correcting the keystone distortion manually, the automatic keystone correction function will operate and the corrected picture will return to its previous incorrect condition. In addition, if you change the input signal and press the AUTO SETUP button, the keystone correction may be cancelled depending on the type of signal and the angle of tilt of the projector. To prevent them from happening, you can set "AUTO KEYSTONE" in the OPTION menu to "OFF"
- The greater the correction of keystone distortion amount, the more the picture quality will deteriorate, and the harder it will become to achieve a good level of focus. To obtain the best picture quality, set up the projector and screen in such a way that the amount of keystone correction required is as minimal as

possible.

- The picture size will also change when correction of keystone distortion is carried out.
- The range of keystone correction varies depending on the type of signal being input (including when no signal is being input). If you make an adjustment that is outside the allowable range, the setting will not be changed. In addition, if the input signal changes after keystone correction has been carried out, the correction setting may be cancelled. This indicates that the current correction setting exceeds the allowable range for the new input signal.
- If you correct both vertical and horizontal keystone distortion at the same time, the allowable range of keystone correction becomes smaller. If you make an adjustment that is outside the allowable range, the setting will not be changed.
- The ratio of length and width of an image may become incorrect depending on the amount of the keystone correction.

OSD POSITION

Press the ◀ or ▶ buttons to move the OSD position.

ASPECT

This setting is only valid for an S-VIDEO/VIDEO signal and a YPBPR signal in 525i (480i), 525p (480p) and 625i format.

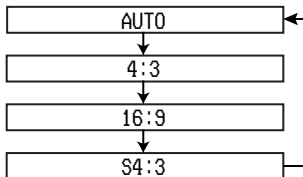

AUTO

(S-VIDEO only)

When an S1 video signal is input to the S-VIDEO terminal, the aspect

ratio is changed automatically to project a 16:9 picture.

4:3

The input signal is projected without change.

16:9

The picture is compressed to a ratio of 16:9 and projected.

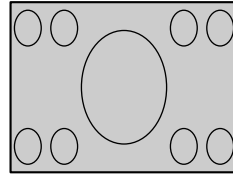

When a squeezed signal is being input. (The projected image is contracted vertically)

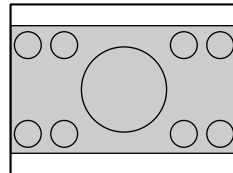

S4:3

The size of the input signal is compressed to 75% and projected. (This is useful for projecting a picture with a 4:3 aspect ratio onto a 16:9 screen.)

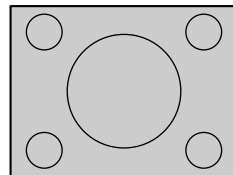

When a 4:3 signal is being input

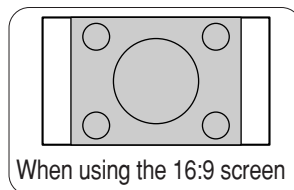
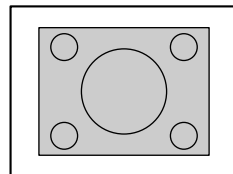

When using the 16:9 screen

S1 video signals

- S1 video signals are a type of video signal with an aspect ratio of 16:9 which include a detector signal. This detector signal is output by some sources such as wide-vision video decks. If the AUTO setting above is selected, this projector will recognise the detector signal and automatically switch the aspect ratio to 16:9 in order to project the picture.

NOTE:

- This projector is equipped with an aspect ratio selection function. However, if a mode which does not match the aspect ratio of the input signal is selected, it may affect the quality of viewing of the original picture. Keep this in mind when selecting the aspect ratio.
- If using this projector in places such as cafes or hotels with the aim of displaying programs for viewing for a commercial purpose or for public presentation, note that if the aspect ratio (16:9) selection function is used to change the aspect ratio of the screen picture, you may be infringing the rights of the original copyright owner for that program under copyright protection laws.
- If a normal (4:3) picture which was not originally intended for wide-screen viewing is projected onto a wide screen, distortion may occur around the edges of the picture so that part of the picture is no longer visible. Such programs should be viewed in 4:3 mode to give proper consideration to the aims and intentions of the original program's creator.

RESIZING

This should normally be set to "ON". (This setting is only for signals which have lower resolutions than the LCD panels. Refer to page 62 for details.)

ON

The pixel resolution of the input signal is converted to the same resolution as the LCD panels before being projected. For signals with lower resolutions, gaps in the pixels are automatically interpolated into the picture before it is projected.

This may sometimes cause problems with the quality of the picture.

OFF

The picture signal is projected at its original resolution, with no pixel conversion. The projected picture will be smaller than normal, so adjust the zoom setting or move the projector forwards or backwards to adjust the picture size if necessary. If set to "OFF", some features, such as D.ZOOM (digital zoom) or keystone distortion correction will not function.

AUTO SETUP

This item functions in the same way as the AUTO SETUP button on the remote control unit. (page 27)

FRAME LOCK

If the picture's condition is bad while a RGB moving picture signal is projected, set the FRAME LOCK to "ON". Refer to page 62 on compatible RGB signals.

Audio adjustment

Select the items by pressing the ▲ or ▼ buttons on the remote control unit or the projector.

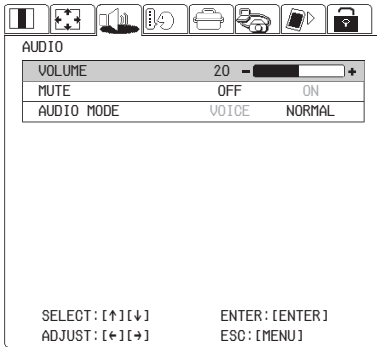

VOLUME

Press the ◀ or ▶ buttons to adjust the volume of the sound output by the projector's built-in speaker.

MUTE

Set the MUTE to "ON" pressing the ◀ or ▶ buttons to turn off the volume of the sound output.

To release muting, set to "OFF" pressing the ◀ or ▶ buttons.

AUDIO MODE

Set to "VOICE" by using the ◀ and ▶ buttons when the sound output is mainly conversations. The sound will become easier to hear.

Changing the display language

Use the ▲, ▼, ◀ and ▶ buttons on the projector or remote control unit to select a language, then press the ENTER button to accept the setting.



Option settings

Use the ▲ and ▼ buttons on the projector or remote control unit to select an item, then press the ◀ or ▶ buttons to change the setting.

OPTION		
OSD	OFF	ON
AUTO SEARCH	OFF	ON
AUTO SIGNAL	OFF	ON
AUTO KEYSTONE	OFF	ON
RGB2 SELECT	INPUT	OUTPUT
RGB/YPbPr	RGB	YPbPr
UGA60/S25P	UGA60	S25P
BLACKBORD	OFF	ON
BACK COLOR	BLUE	BLACK
NEXT PAGE ↓		

SELECT: [↑][↓]
ADJUST: [+][+] ESC: [MENU]

OPTION		
PREVIOUS PAGE ↑		
FRONT/REAR	FRONT	REAR
DESK/CEILING	DESK	CEILING
FAN CONTROL	STANDARD	HIGH
LAMP POWER	LOW	HIGH
LAMP RUN TIME		10 H
FUNC1	MUTE	KEYSTONE
CONTROL KEY	OFF	ON
AUTO POWER OFF		DISABLE

SELECT: [↑][↓]
ADJUST: [+][+] ESC: [MENU]

OSD

ON

The current input name is displayed in the top-right corner of the screen when the input signal is changed.

OFF

Use this setting when you do not want the current input name to be displayed.

AUTO SEARCH

ON

The input signal will be detected and selected automatically when the Input select (RGB, VIDEO) buttons are pressed for a few seconds. (page 14)

OFF

AUTO SEARCH is disabled.

NOTE:

- AUTO SEARCH will not function when the input signal is being projected.

(PT-L735NTU only)

AUTO SEARCH will not function when NETWORK or SD CARD is selected. NETWORK and SD CARD cannot be searched even when these signals are being input.

AUTO SIGNAL

This should normally be set to "ON".

ON

AUTO SETUP will be carried out automatically when the input signal is changed. (page 27)

OFF

AUTO SETUP will not function when the input signal is changed.

AUTO KEYSTONE

This should normally be set to "ON".

ON

During automatic setup, the angle of tilt of the projector is detected and keystone distortion is corrected automatically.

OFF

Use this setting when you do not want automatic keystone correction to be carried out during automatic setup, such as when the screen itself is at an angle.

RGB2 SELECT

This setting is used to select the function of the RGB2 IN/RGB1 OUT connector.

RGB/YPbPr

This setting is valid when 750p, HDTV60, HDTV50, 525p, 625i and 525i signals are being input. Select the setting in accordance with the input signal.

The RGB/YPbPr item is displayed when the RGB1 IN or RGB2 IN connector has a signal being input.

VGA60/525P

When a VGA60 or 525p RGB signal is being input, select the signal in accordance with the input signal.

BLACKBOARD

Set to "ON" when PICTURE MODE is set to BLACKBOARD. (Refer to page 37.)

BACK COLOR

This sets the color which is projected onto the screen when no signal is being input to the projector.

FRONT/REAR

This setting should be changed in accordance with the projector setting-up method.

Set to "FRONT" when using a normal reflective screen with the projector positioned in front of the screen, and set to "REAR" when using a translucent screen with the projector positioned behind the screen.

DESK/CEILING

This setting should be changed in accordance with the projector setting-up method.

Set to "DESK" when setting up the projector on a desk or similar, and set to "CEILING" when suspending the projector from the ceiling using the ceiling bracket which is sold separately.

FAN CONTROL

Set FAN CONTROL to "HIGH", when using this projector at high elevations (above 1 400 m) only.

LAMP POWER

This setting changes the lamp brightness. When set to "LOW", the luminance of the lamp is reduced, but the projector uses less power, and the operating noise is also reduced.

This can help to extend the lamp's operating life. If using the projector in small rooms where high luminance is not required, it is recommended that you set the LAMP POWER to "LOW".

LAMP RUN TIME

This setting displays the usage time for the lamp unit which is currently being used.

NOTE:

- The lamp's operating life varies depending on the usage conditions (such as the LAMP POWER setting and the number of times the power is turned on and off).

FUNC 1

This assigns a function to the FUNC1 button of the remote control unit .

MUTE

Functions in the same way as the MUTE function. (page 44)

KEYSTONE

Functions in the same way as when "KEYSTONE" is selected from the POSITION menu screen. (page 41)

CONTROL KEY

To disable the buttons on the projector, set CONTROL KEY to "OFF". A confirmation screen will then be displayed. Select "OK" by using ◀ and ▶ buttons. To use the buttons on the projector, set to "ON" by using the remote control unit.

AUTO POWER OFF

If any signal is not input into the projector during the time that you set up, the projector will return to standby mode. The auto power off time can be set to, from 15 minutes to 60 minutes, by 5 minutes. If you don't use this feature, set it to "DISABLE". This feature will not function under the following situation.

- 1) When using the freeze function.
- 2) When the NETWORK or SD CARD is selected (PT-L735NTU only).
- 3) When writing the data in the SD memory card (PT-L735NTU only).

NOTE:

(PT-L735NTU only)

- When the projector is connected to a personal computer by means of the wireless network using the accessory wireless card, the projector will go in the WEB STANDBY. (page 48)

Network setup (PT-L735NTU only)

You need make adjustment on some items when controlling the projector with a personal computer by means of the wireless network. Refer to the accessory CD-ROM for details.

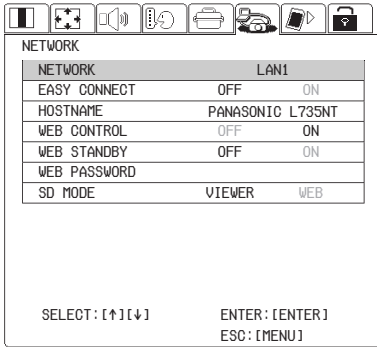

NETWORK

Network settings can be selected and you can then make further settings.

EASY CONNECT

This item is for setting whether the EASY CONNECT function is used or not.

HOSTNAME

The host name for this projector can be set.

WEB CONTROL

To control the projector with a personal computer by means of the wireless network, set the WEB CONTROL to "ON". To prevent it, set to "OFF".

WEB STANDBY

To turn on and off the power with a personal computer by means of the wireless network, set the WEB STANDBY to "ON".

When the WEB STANDBY is set to "ON", the cooling fan operates and the power indicator on the projector flashes slowly in red.

WEB PASSWORD

You can set the password for controlling the projector with a personal computer by means of the wireless network.

SD MODE

The playback methods can be set when SD CARD is selected.

SD card setup (PT-L735NTU only)

The following settings are used when projecting the pictures recorded in the SD memory card. Refer to the accessory CD-ROM for details.

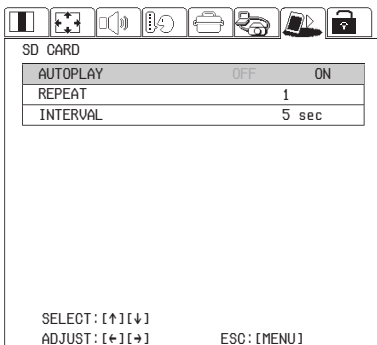

AUTO PLAY

Plays the pictures recorded in the SD memory card automatically.

REPEAT

This setting is for adjusting the times of the auto play.

INTERVAL

This setting is adjusting the interval of the auto play.

Setting up the SECURITY function

This projector is equipped with a security function. A password input screen can be displayed, or a company URL can be set up and displayed at the bottom of the projected image. A logo also can be displayed before projection.

Use the ◀ and ▶ buttons on the projector or remote control unit to select SECURITY, then press the ▼ button.

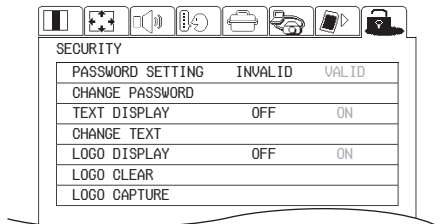

A screen for entering a password. It features a label "PASSWORD" followed by a text input field. Below the field, there are two options: "OK: [ENTER]" and "CANCEL: [MENU]".

(When you use the SECURITY function for the first time)
Press the ▲, ▶, ▼, ◀, ▲, ▶, ▼ and ◀ buttons in order, then press the ENTER button.

(When a password change has been made before)
Type in the changed password, then press the ENTER button.

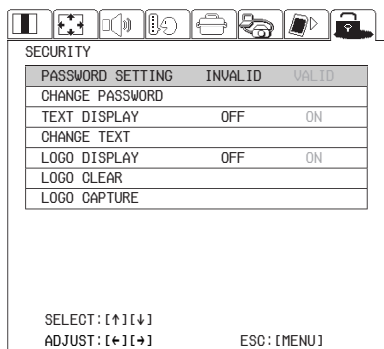

PASSWORD SETTING

The password input screen can be displayed when the power is turned on. All of the controls other than the POWER button are disabled unless the password is entered correctly.

VALID

PASSWORD SETTING is enabled.

INVALID

PASSWORD SETTING is disabled. The password input screen will not be displayed when the power is turned on.

CHANGE PASSWORD

Passwords can be changed. Press the ENTER button to display the CHANGE PASSWORD screen.

A screen for confirming a password change. It has two input fields: "NEW" and "CONFIRM". Below the fields, there are two options: "OK: [ENTER]" and "CANCEL: [MENU]".

- ① Set a password by pressing the ▲, ▼, ◀, and ▶ buttons on the remote control unit. (A maximum of 8 buttons can be set.)
- ② Press the ENTER button.
- ③ Enter the password again for confirmation.
- ④ Press the ENTER button. (Password change will be completed.)

NOTE:

- The entered password will appear as *. It will not be displayed on the screen.
- If you enter the wrong password, the letters "PASSWORD" and "NEW" will become red. Enter the correct password again.

TEXT DISPLAY

The setup letters can be displayed at the bottom of the projected image while an image is projected.

ON

TEXT DISPLAY is enabled.

OFF

TEXT DISPLAY is disabled.

CHANGE TEXT

The setup letters which will be displayed when TEXT DISPLAY is set to "ON" can be changed. Press the ENTER button to display the CHANGE TEXT screen.

Above: Setting before change

Below: Setting after change

Cursor

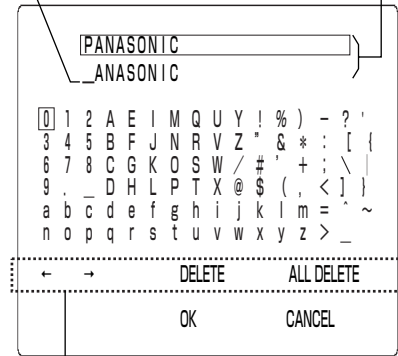

Editing items

- ① Use the ▲, ▼, ◀ and ▶ buttons to select the characters, then press the ENTER button. (You can enter 20 characters continuously.)

<Editing Items>

←

Moves cursor to left.

→

Moves cursor to right.

DELETE

Deletes a letter on the cursor.

ALL DELETE

Deletes all the letters.

- ② Use the ▲, ▼, ◀ and ▶ buttons to select "OK", then press the ENTER button.

- Select "CANCEL" to cancel the change.

NOTE:

- The letters which cannot be input will be displayed in gray, and cannot be selected in CHANGE TEXT.

LOGO DISPLAY

A logo can be displayed before projection.

ON

LOGO DISPLAY is enabled.

OFF

LOGO DISPLAY is disabled.

LOGO CLEAR

Captured logo data can be cleared. Press the ENTER button to display the confirmation screen, and then select "OK".

LOGO CAPTURE

A logo can be captured from the picture being projected. Press the ENTER button to display the capture adjustment screen.

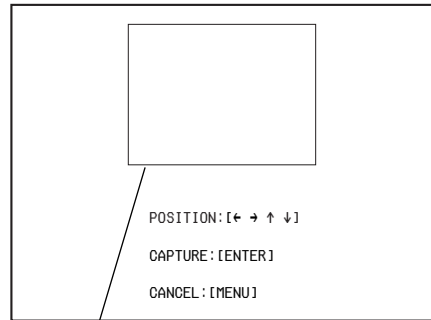
**Capturing frame**

- ① Use the ▲ ▼ ◀ ▶ buttons to move the capturing frame to the area you want to capture.
- ② Press the ENTER button.
 - The letters "CAPTURE ..." and the progress status will be displayed while logo capture is being carried out.

NOTE:

- The size of the capturing frame varies depending on the signals being input.
- Fine images such as landscapes may be unable to be captured.
- Only RGB signals can be captured. (Except 525i, 625i, 525p, HDTV60, HDTV50, and 750p. Refer to page 62 for details.)
- Images with 512x384 pixels can be captured.
- It is recommended that you input XGA signals, and set KEYSTONE to "0" when carrying out LOGO CAPTURE.

When the TEMP indicator and the LAMP indicator are illuminated

There are two indicators on the control panel of the projector which give information about the operating condition of the projector. These indicators illuminate or flash to warn you about problems that have occurred inside the projector, so if you notice that one of the indicators is on, turn off the power and check the table below for the cause of the problem.

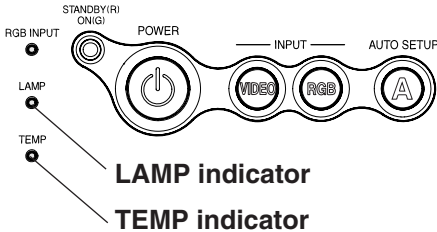

TEMP indicator		
Indicator display	Illuminated (red) (Lamp unit on)	Flashing (red) (Lamp unit off)
Problem	The ambient temperature or the temperature inside the projector has become unusually high or low.	The ambient temperature or the temperature inside the projector has become too high or low, causing the lamp unit to be automatically shut off.
Possible cause	<ul style="list-style-type: none"> • The ventilation holes may be covered. • The ambient temperature in the place of use may be too high. • The air filter may be blocked. • The ambient temperature in the place of use may be too low. 	
Remedy	<ul style="list-style-type: none"> • Uncover the ventilation holes. • Set up the projector in a place where the temperature is between 0 °C (32 °F) and 40 °C (104 °F) and the humidity is between 20% and 80% (with no condensation). [If you set the FAN CONTROL to “HIGH” (page 46), set up the projector in a place where the temperature is between 0 °C (32 °F) and 35 °C (95 °F) and the humidity is between 20% and 80% (with no condensation).] • Turn off the MAIN POWER switch by following the procedure on page 25, and then clean the air filter (refer to page 54). 	

LAMP indicator			
Indicator display	lluminated (red)	Flashing (red)	
Problem	It is nearly time to replace the lamp unit.	An abnormality has been detected in the lamp circuit.	
Possible cause	<ul style="list-style-type: none"> Does “REPLACE LAMP” appear on the screen after the projector is turned on? 	<ul style="list-style-type: none"> The power may have been turned on straight away after it was turned off. 	<ul style="list-style-type: none"> There may be an abnormality in the lamp circuit.
Remedy	<ul style="list-style-type: none"> This occurs when the operation time for the lamp unit is nearing 1800 hours. (when LAMP POWER has been set to “HIGH”) Ask your dealer or an Authorized Service Center to replace the lamp unit. 	<ul style="list-style-type: none"> Wait for a while until the lamp unit cools down before turning the power back on again. 	<ul style="list-style-type: none"> Turn off the MAIN POWER switch by following the procedure given on page 25, and then contact an Authorized Service Center.

NOTE:

- Be sure to turn off the MAIN POWER switch by following the procedure given in “Turning off the power” on page 25 before carrying out any of the procedures in the “Remedy” column.
- If the main power turns off after the TEMP indicator starts flashing, it means that an abnormality has occurred. Please contact an Authorized Service Center so that the necessary repairs can be made.

Cleaning and replacing the air filter

If the air filter becomes clogged with dust, the internal temperature of the projector will rise, the TEMP indicator will flash and the projector power will turn off. **The air filter should be cleaned after every 100 hours of use.**

- ① **Turn off the MAIN POWER switch and disconnect the power cord plug from the wall outlet.**

Turn off the MAIN POWER switch according to the procedure given in "Turning off the power" on page 25 before disconnecting the plug from the wall outlet.

- ② **Gently turn the projector upside down.**

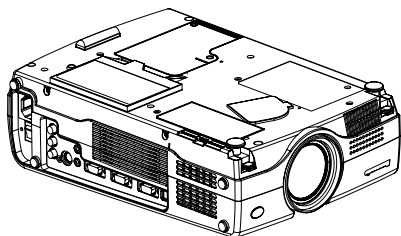

NOTE:

- Place the projector on top of a soft cloth so that it will not become scratched.

- ③ **Remove the air filter.**

Put your fingernails under the air filter and pull the air filter out of the projector.

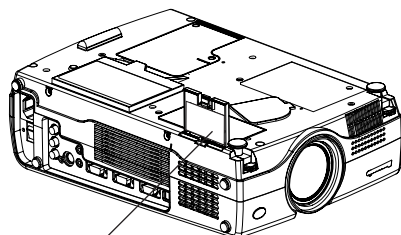

Air filter

- ④ **Clean the air filter.**

Soak the air filter in water and wash out dirt by hand.

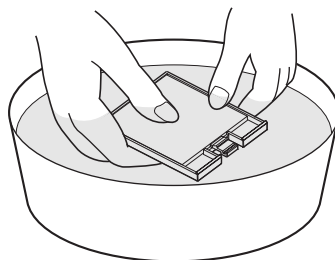

NOTE:

- Do not use detergent.
- Be careful not to separate the air filter cover from the frame when washing the air filter.

- ⑤ **Dry the air filter and install it to the projector.**

NOTE:

- Be sure to install the air filter cover before using the projector. If the projector is used without the air filter cover installed, dust and other foreign particles will be drawn into the projector, and malfunctions will result.
- If the dust cannot be removed by cleaning, it is time to replace the air filter. Please consult your dealer. Furthermore, if the lamp unit is being replaced, replace the air filter at this time also.

Replacing the lamp unit

Warning

The lamp unit should only be replaced by a qualified technician.

When replacing the lamp, allow it to cool for at least one hour before handling it.

- The lamp cover gets very hot, and contact with it can cause burns.

Notes on replacing the lamp unit

- The light generating lamp is made of glass, so dropping it or allowing it to hit hard objects may cause it to burst. Be careful when handling the lamp.
- After having removed the old lamp, carelessly discarding it can cause the lamp to burst. Dispose of the lamp with the same care that would be taken with a fluorescent light.
- A Phillips screwdriver is necessary for removing the lamp unit. Make sure that your hands are not slippery when using the screwdriver.

NOTE:

- The projector is not supplied with a replacement lamp unit. Please ask your dealer for details. Lamp unit product no.: **ET-LA735**

CAUTION:

- Do not use any lamp unit other than the one with the product number indicated above.

Lamp unit replacement period



The lamp is a consumable product. Even when the full life of the bulb has not been exhausted, the brightness of the light will gradually decline. Therefore periodic replacement of the lamp is necessary.

The intended lamp replacement interval is 2 000 hours, but it is possible that the lamp may need to be replaced earlier due to variables such as a particular lamp's characteristics, usage conditions and the installation environment. Early preparation for lamp replacement is encouraged.

A lamp that has exceeded 2 000 hours of use has a much greater chance of exploding. In order to prevent the lamp from exploding, the lamp will be automatically shut off when 2 000 hours of use have been reached.

NOTE:

- The usage hours explained above are for use when the HIGH setting has been selected for LAMP POWER in the OPTION menu. If the "LOW" setting is selected, the brightness of the lamp will be less and life of the lamp can be extended.
- While 2 000 hours is the intended replacement interval, it is not a period of time covered by warranty.

	<p>On-screen display</p> 	<p>Lamp indicator warning light</p> 
More than 1 800 hours	Displayed for 30 seconds. Pressing any button will clear the display.	Illuminates red during image projection and standby mode.
More than 2 000 hours	Remains displayed until any button is pressed.	

Lamp unit replacement procedure

NOTE:

- If the lamp usage time has passed 2 000 hours (when LAMP POWER has been set to “HIGH”), the projector will switch to standby mode after approximately 10 minutes of operation. The steps ⑦ to ⑾ on the next page should thus be completed within 10 minutes.

- ① Turn off the MAIN POWER switch according to the procedure given in “Turning off the power” on page 25, and then disconnect the power cord plug from the wall outlet and check that the area around the lamp unit has cooled down.
- ② Use a Phillips screwdriver to turn the lamp unit cover fixing screws at the bottom of the projector, and then remove the lamp unit cover from the projector.

Lamp unit cover

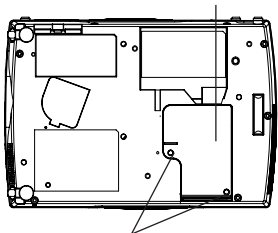

Lamp unit cover fixing screws

- ③ Use a Phillips screwdriver to loosen the two lamp unit fixing screws until the screws turn freely. Then hold the handle of the lamp unit and gently pull it out from the projector.

Lamp unit fixing screws

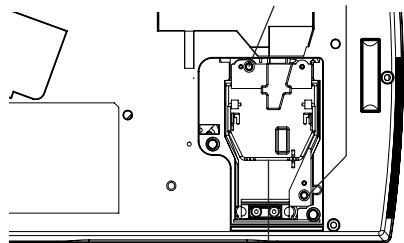

Handle

- ④ Insert the new lamp unit while making sure that the direction of insertion is correct, and then use a Phillips screwdriver to securely tighten the lamp unit fixing screws.

- ⑤ Install the lamp unit cover, and then use a Phillips screwdriver to securely tighten the lamp unit cover fixing screws.

NOTE:

- Be sure to install the lamp unit and the lamp unit cover securely. If they are not securely installed, it may cause the protection circuit to operate so that the power cannot be turned on.

- ⑥ Insert the power cord plug into the wall outlet and then press the MAIN POWER switch.

NOTE:

- If the POWER indicator on the projector does not illuminate red when the MAIN POWER switch is turned on, turn the MAIN POWER switch off again, unplug the power cord from the electrical outlet, and check that the lamp unit and the lamp unit cover are securely installed. Then turn the MAIN POWER switch back on.

- ⑦ Press the POWER button so that a picture is projected onto the screen.

- ⑧ Press the MENU button to display the MENU screen, and select “OPTION” by pressing the ◀ or ▶ buttons.

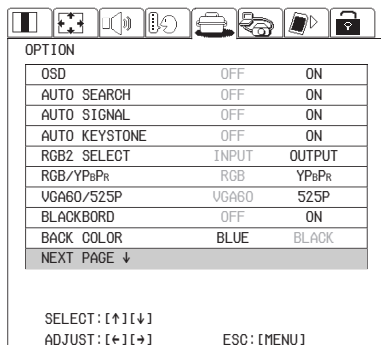

- ⑨ Select the “LAMP RUN TIME” by pressing the ▲ or ▼ buttons.

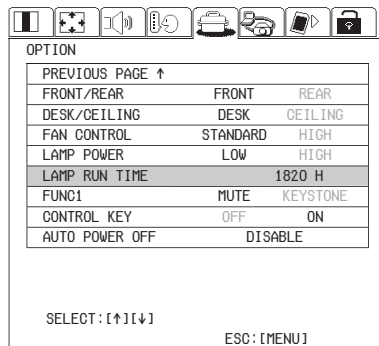

- ⑩ Press and hold the ENTER button for approximately 3 seconds.

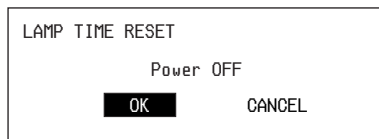

The “LAMP TIME RESET” will be displayed.

- ⑪ Select “OK” by pressing the ◀ or ▶ buttons and press the ENTER button.

NOTE:

- If “CANCEL” is selected in step ⑪, the operation for resetting the lamp time will be cancelled.

- ⑫ Turn off the power.

This will reset the cumulative usage time for the lamp unit to zero.

Refer to page 25 for details on how to turn off the power.

Before calling for service

Before calling for service, check the following points.

Problem	Possible cause	Page
Power does not turn on.	● The power cord may not be connected.	–
	● The MAIN POWER switch is turned off.	–
	● The main power supply is not being supplied to the wall outlet.	–
	● TEMP indicator is illuminated or flashing.	52
	● LAMP indicator is illuminated or flashing.	53
No picture appears.	● The video signal input source may not be connected properly.	–
	● The input selection setting may not be correct.	24
	● The BRIGHT adjustment setting may be at the minimum possible setting.	38
	● The shutter function may be in use.	28
The picture is fuzzy.	● The lens cover may still be attached to the lens.	–
	● The lens focus may not have been set correctly.	24
	● The projector may not be at the correct distance from the screen.	19
	● The lens may be dirty.	–
	● The projector may be tilted too much.	19
COLOR is too light or TINT is poor.	● COLOR or TINT adjustment may be incorrect.	38
	● The input source which is connected to the projector may not be adjusted correctly.	–
No sound can be heard.	● The audio signal source may not be connected properly.	–
	● The volume adjustment may be at the lowest possible setting.	29, 44
	● A cable may be connected to the AUDIO OUT jack.	20, 21
	● The MUTE function may be active.	44
The remote control unit does not operate.	● The battery may be weak.	–
	● The battery may not be inserted correctly.	22
	● The remote control signal receptor on the projector may be obstructed.	22
	● The remote control unit may be out of the operation range.	22
The buttons on the projector do not function.	● The CONTROL KEY may be set to “OFF”. In order to set the CONTROL KEY to “ON” without using the remote control unit, keep holding down the ENTER button on the projector and press the MENU button for more than 2 seconds. It will then be turned ON.	47

Problem	Possible cause	Page
The picture does not display correctly.	<ul style="list-style-type: none"> ● The signal format (TV system) may not be set correctly. 	38
	<ul style="list-style-type: none"> ● There may be a problem with the video tape or other signal source. 	–
	<ul style="list-style-type: none"> ● A signal which is not compatible with the projector may be being input. 	62
Picture from computer does not appear.	<ul style="list-style-type: none"> ● The cable may be too long. 	–
	<ul style="list-style-type: none"> ● The external video output for the laptop computer may not be set correctly. (You may be able to change the external output settings by pressing the [Fn]+[F3] or [Fn]+[F10] keys simultaneously. The actual method varies depending on the type of computer, so refer to the documentation provided with your computer for further details.) 	–
	<ul style="list-style-type: none"> ● If an RGB input indicator is turned off, the video signals may not be output from the computer. ● RGB2 SELECT in the OPTION menu is set to OUTPUT when the signals are input to RGB2 IN / RGB1 OUT connector. 	14, 26 45

Cleaning and maintenance

Before carrying out cleaning and maintenance, be sure to disconnect the power cord plug from the wall outlet.

Wipe the cabinet with a soft, dry cloth.

If the cabinet is particularly dirty, soak the cloth in water with a small amount of neutral detergent in it, squeeze the cloth very well, and then wipe the cabinet. After cleaning, wipe the cabinet dry with a dry cloth. If using a chemically-treated cloth, read the instructions supplied with the cloth before use.

Do not wipe the lens with a cloth that is dusty or which produces lint.

If any dust or lint gets onto the lens, such dust or lint will be magnified and projected onto the screen. Use a blower to clean any dust and lint from the lens surface, or use a soft cloth to wipe off any dust or lint.

Specifications

Power supply:	100 V–240 V ~, 50 Hz/60 Hz
Power consumption:	280 W (During standby (when fan is stopped): Approx. 5 W - 7 W) [When the WEB STANDBY is set to “ON” (PT-L735NTU only) : Approx. 30 W (page 48)]
Amps:	3.5 A–1.8 A
LCD panel:	
Panel size (diagonal):	0.9 type (22.86 mm)
Aspect ratio:	4:3 (16:9 compatible)
Micro lens array:	Available
Display method:	3 transparent LCD panels (RGB)
Drive method:	Active matrix method
Pixels:	786 432 (1 024 x 768) x 3 panels
Lens:	Manual zoom (1 - 1.3) / focus lens F 1.7 - 2.1, f 28.7 mm - 36.0 mm
Lamp:	UHM lamp (200 W)
Luminosity:	2 600 lm/ANSI
Scanning frequency(for RGB signals):	
Horizontal scanning frequency:	15 kHz–91 kHz
Vertical scanning frequency:	50 Hz–87 Hz
Dot clock frequency:	Less than 100 MHz
YPbPr signals:	525i (480i), 525p (480p), 625i (576i), 750p (720p), 1 125i (1 080i)
Color system:	7 (NTSC/NTSC 4.43/PAL/PAL-M/PAL-N/ PAL60/SECAM)
Projection size:	1 016 mm - 7 620 mm (40" - 300")
Throw distance:	1.2 m - 11.8 m (3'11" - 38'8")
Optical axis shift:	9:1 (fixed)
Screen aspect ratio:	4:3
Installation:	Front/Rear/Ceiling/Desk (Menu selection method)
Speaker:	2 pieces
Max. useable volume output:	5 W + 5 W (Stereo)
Connectors	
RGB IN/OUT:	Dual-line D-SUB HD 15-pin (female) (One-line is available for input and output)
During YPbPr input/output:	
Y:	1.0 V [p-p], 75 Ω
Pb,Pr :	0.7 V [p-p], 75 Ω

During RGB input/output:	
R.G.B.:	0.7 V [p-p], 75 Ω
G.SYNC:	1.0 V [p-p], 75 Ω
HD/SYNC:	TTL, automatic plus/minus polarity compatible
VD:	TTL, automatic plus/minus polarity compatible
AUDIO IN (for RGB):	Single-line 0.5 V [rms] M3 jack (Stereo MINI)
VIDEO IN:	Single-line, RCA pin jack 1.0 V [p-p], 75 Ω
S-VIDEO IN:	Single-line, Mini DIN 4-pin Y 1.0 V [p-p], C 0.286 V [p-p], 75 Ω
AUDIO IN (for S-VIDEO/VIDEO):	0.5 V [rms] RCA pin jack x 2 (L-R)
AUDIO OUT:	M3 jack (Stereo MINI) (Monitor output/stereo compatible) 0 V [rms] - 2.0 V [rms] (variable)
Serial connector:	D-sub 9p (female) RS-232C compatible
Cabinet:	Moulded plastic (ABS/PC)
Dimensions:	
Width:	248 mm (9-3/4") (Not including projecting parts)
Height:	115 mm (4-1/2")
Length:	359 mm (14-1/8") (Not including lens)
Weight:	4.2 kg (9.3 lbs.)
Operating environment:	
Temperature:	0 °C–40 °C (32 °F–104 °F) [When the FAN CONTROL is set to "HIGH" (page 46); 0 °C–35 °C (32 °F–95 °F)]
Humidity:	20%–80% (no condensation)
Certifications:	UL60950, C-UL FCC Class B
<hr/>	
<Remote control unit>	
Power supply:	3 V DC (AAA battery x2)
Operating range:	Approx. 7 m (23') (when operated directly in front of signal receptor)
Weight:	108 g (3.8 ozs.) (including batteries)
Dimensions:	
Width:	33 mm (1-9/32")
Length:	168 mm (6-19/32")
Height:	40 mm (1-9/16")
<hr/>	
<Options>	
Ceiling bracket	ET-PK735
Wireless mouse receiver	ET-RMRC2
Wide conversion lens	ET-LEC701
Wireless card	ET-CDWL2U

Appendix

List of compatible signals

Mode	Display resolution (dots)*1	Scanning frequency		Dot clock frequency (MHz)	Picture quality*2	Resizing*3	Format
		H (kHz)	V (Hz)				
NTSC/NTSC4.43/ PAL-M/PAL60	720 x 480i	15.734	59.940		A	OK	Video/S-Video
PAL/PAL-N/SECAM	720 x 576i	15.625	50.000		A	OK	Video/S-Video
525i	720 x 480i	15.734	59.940	13.500	A	OK	YPbPr/RGB
625i	720 x 576i	15.625	50.000	13.500	A	OK	YPbPr/RGB
525p	720 x 483	31.469	59.940	27.000	A	OK	YPbPr/RGB
HDTV60	1 920 x 1 080i	33.750	60.000	74.250	A		YPbPr/RGB
HDTV50	1 920 x 1 080i	28.125	50.000	74.250	A		YPbPr/RGB
750P	1 280 x 720	45.000	60.000	74.250	A		YPbPr/RGB
VESA70	640 x 400	31.469	70.086	25.175	A	OK	RGB
VESA85	640 x 400	37.861	85.081	31.500	A	OK	RGB
VGA60 *4	640 x 480	31.469	59.940	25.175	A	OK	RGB
VGA65	640 x 480	35.000	66.667	30.240	A	OK	RGB
VGA72	640 x 480	37.861	72.809	31.500	A	OK	RGB
VGA75	640 x 480	37.500	75.000	31.500	A	OK	RGB
VGA85	640 x 480	43.269	85.008	36.000	A	OK	RGB
SVGA55	800 x 600	35.156	56.250	36.000	A	OK	RGB
SVGA60 *4	800 x 600	37.879	60.317	40.000	A	OK	RGB
SVGA70	800 x 600	48.077	72.188	50.000	A	OK	RGB
SVGA75	800 x 600	46.875	75.000	49.500	A	OK	RGB
SVGA85	800 x 600	53.674	85.061	56.250	A	OK	RGB
MAC16	832 x 624	49.725	74.550	57.283	A	OK	RGB
XGA60 *4	1 024 x 768	48.363	60.004	65.000	AA		RGB
XGA70	1 024 x 768	56.476	70.069	75.000	AA		RGB
XGA75	1 024 x 768	60.023	75.029	78.750	AA		RGB
XGA85	1 024 x 768	68.678	84.997	94.500	AA		RGB
XGA85i	1 024 x 768i	35.520	86.952	44.897	AA		RGB
MXGA70	1 152 x 864	63.995	71.184	94.200	A		RGB
MXGA75	1 152 x 864	67.500	74.917	108.000	B		RGB
MXGA85	1 152 x 864	76.705	85.038	121.500	B		RGB
MAC21	1 152 x 870	68.681	75.062	100.000	B		RGB
MSXGA60 *4	1 280 x 960	60.000	60.000	108.000	B		RGB
SXGA60 *4	1 280 x 1 024	63.981	60.020	108.000	B		RGB
SXGA75	1 280 x 1 024	79.977	75.025	135.001	B		RGB
SXGA85	1 280 x 1 024	91.146	85.024	157.500	B		RGB
SXGA60+ *4	1 400 x 1 050	63.981	60.020	108.000	B		RGB
UXGA60 *4	1 600 x 1 200	75.000	60.000	162.000	B		RGB

*1 The "i" appearing after the resolution indicates an interlaced signal.

*2 The following symbols are used to indicate picture quality.

AA Maximum picture quality can be obtained.

A Signals are converted by the image processing circuit before picture is projected

B Some loss of data occurs to make projection easier.

*3 Signals with "OK" in the Resizing column can be set using the RESIZING command in the POSITION menu. (Refer to page 43.)

*4 Signals that are compatible with the FRAME LOCK function. (page 43.)

Connector pin wiring

- The pin layout and signal names for the S-VIDEO IN connector are shown below.

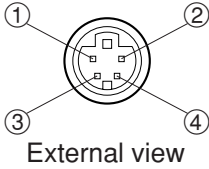

Pin No.	Signal
①	Earth (Luminance signal)
②	Earth (Color signal)
③	Luminance signal
④	Color signal

- The pin layout and signal names for the RGB/Y_PB_PR (RGB1 IN/RGB2 IN) connector are shown below.

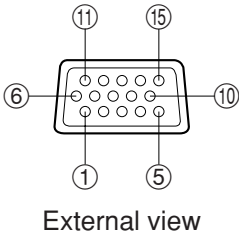

Pin No.	Signal
①	R/P _R
②	G/G _· SYNC/Y
③	B/P _B
⑫	SDA
⑬	HD/SYNC
⑭	VD
⑮	SC _L

Pin ⑨ is spare.

Pins ④–⑧, ⑩ and ⑪ are for earth.

Pins ⑫ and ⑮ functions are only valid when supported by the computer

Projection dimensions calculation methods

If the screen size (diagonal) is SD (m), then the following formula is used to calculate the projection distance for the wide lens position (LW) and the projection distance for the telephoto lens position (LT).

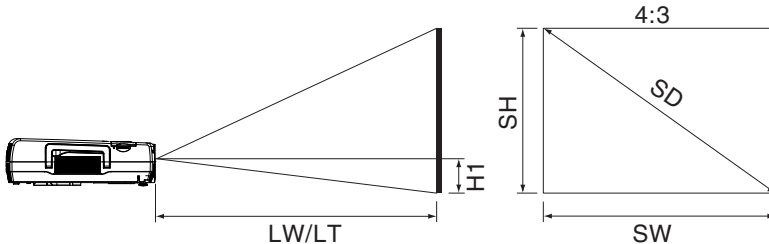

Minimum Projection Distance	$LW=0.031 \times SD / 0.0254 - 0.068$
Maximum Projection Distance	$LT=0.0393 \times SD / 0.0254 - 0.066$

For 16:9 aspect ratios, the following formula can be used to calculate the projection distance.

Minimum Projection Distance	$LW=0.034 \times SD / 0.0254 - 0.068$
Maximum Projection Distance	$LT=0.043 \times SD / 0.0254 - 0.066$

Using the SERIAL connector

The serial connector which is on the side connector panel of the projector conforms to the RS-232C interface specification, so that the projector can be controlled by a personal computer which is connected to this connector.

Connection

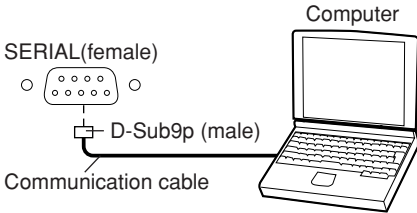

NOTE:

- Use a proper communication cable which is suitable for the personal computer to connect the serial connector and the personal computer.

Pin layout and signal names for SERIAL connector

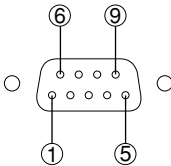

D-SUB 9-pin connector seen from outside

Pin No.	Signal name	Contents
①		NC
②	TXD	Transmitted data
③	RXD	Received data
④		NC
⑤	GND	
⑥	DSR	Connected internally
⑦	CTS	
⑧	RTS	
⑨		NC

Communications settings

Signal level	RS-232C
Sync. method	Asynchronous
Baud rate	9 600 bps
Parity	None
Character length	8 bits
Stop bit	1 bit
X parameter	None
S parameter	None

Basic format

The data sent from the computer to the projector is transmitted in the format shown below.

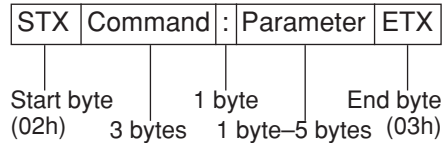

NOTE:

- If sending multiple commands, check that a response has been received from the projector for one command before sending the next command.
- When a command which does not require parameters is sent, the colon (:) is not required.
- If an incorrect command is sent from the personal computer, the “ER401” command will be sent from the projector to the personal computer.

Control commands

The commands which the personal computer can use to control the projector are shown in the following table.

Command	Control Contents	Remarks
PON	Power ON	In standby mode, all commands other than the PON command are ignored. <ul style="list-style-type: none"> • The PON command is ignored during lamp ON control. • If a PON command is received while the cooling fan is operating after the lamp has switched off, the lamp is not turned back on again straight away, in order to protect the lamp.
POF	Power OFF	
AVL	Volume	Parameter 000–063(Adjustment value 0–63)
IIS	Input signal selection	Parameter VID=VIDEO SVD=S-VIDEO RG1=RGB1(YP _B PR1) RG2=RGB2(YP _B PR2) NWP=NETWORK SDC=SDCARD
Q\$\$	Lamp ON condition query	Parameter 0 = Standby 1 = Lamp ON control active 2 = Lamp ON 3 = Lamp OFF control active
OSH	Shutter function	Operation will be switched between ON and OFF each time the command is sent. Do not switch operation ON and OFF after only short periods of time.

Cable specifications

(When connected to a personal computer)

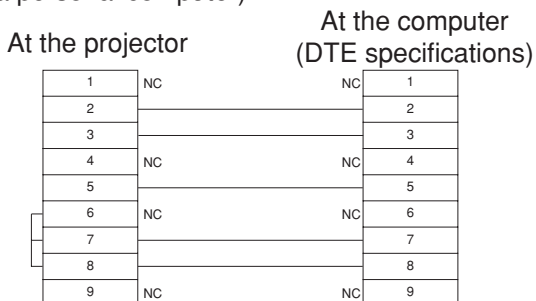

Dimensions

<Units: mm (inch)>

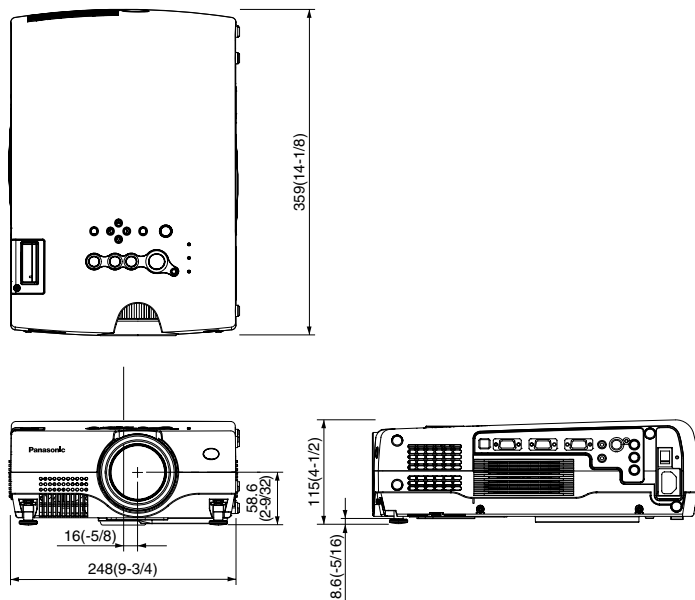

*Not including lens and projecting parts

Trademark acknowledgements

- The SD logo is a trademark.
- Windows is a trademark or registered trademark of Microsoft Corporation in the United States of America and other countries.
- VGA and XGA are trademarks of International Business Machines Corporation.
- Macintosh is a registered trademark of Apple Computer, Inc.
- S-VGA is a registered trademark of the Video Electronics Standards Association.

All other trademarks are the property of the various trademark owners.

These Operating Instructions are printed on recycled paper.

Panasonic[®]

Professional/Industrial Video

Panasonic Broadcast & Television Systems Company

Division of Matsushita Electric Corporation of America

One Panasonic Way 4E-7 Secaucus, NJ 07094 (201) 392-4443
3330 Cahuenga Blvd West Los Angeles, CA 90068 (323) 436-3500

Technical Support:

(800) 524-1448

(800) 526-6610

FAX: (201) 392-6514

E-Mail: pbtssupport@panasonic.com

Printed in Japan
S0503-2063C